

**Supplementary description – Translation of the original
Connection examples for RS-422 interface**

BCS36x8^{ex} Series

Type 17-A1S4-*HP*
ATEX / IECEx Zone 1/21
NEC / CEC Class I, II, III Division 1

Type B7-A2S4-*HP* and B7-A2S4-*ER*
ATEX / IECEx Zone 2/22
NEC / CEC Class I, II, III Division 2

Date: Rev. - / 10th November 2020

Disclaimer: We reserve the right to make technical changes. Changes, errors and misprints shall not justify any claim for damages.

Table of contents

Table of contents.....	2
1. About this documentation.....	3
1.1 Technical changes.....	3
1.2 Languages.....	3
1.3 Other relevant documents.....	4
2. Note.....	5
3. Programming Tools.....	5
4. Wired BCS3608 ^{ex} hand-held scanner.....	7
4.1 Connection RS-422 to PC via universal supply module.....	7
4.1.1 Components required.....	7
4.1.2 Connection.....	8
4.1.3 Setting/programming.....	12
4.1.4 Testing communication/data transmission.....	13
5. Bluetooth BCS3678 ^{ex} hand-held scanner.....	15
5.1 Connection RS-422 to PC via universal supply module.....	15
5.1.1 Components required.....	15
5.1.2 Connection.....	16
5.1.3 Setting/programming.....	20
5.1.4 Testing communication/data transmission.....	22

1. About this documentation



Read carefully before commissioning the device.

This manual with connection examples is a supplementary description to the BARTEC User Manual.

This manual is aimed at all persons entrusted with using the device.

It is essential to know about and strictly comply with the safety signs and warnings in the BARTEC User Manual.

- Read the User Manual, in particular the safety instructions, carefully before using the device.
- Keep the User Manual for the entire service life of the device.
- Make the User Manual accessible to all those who are entrusted with using the device.

1.1 Technical changes

The current versions of data sheets, manuals, certificates and EC declarations of conformity as well as information about new accessories can be downloaded from www.bartec.de under “Products & solutions” in the “Automation technology” product area, or can be requested directly from BARTEC GmbH.

1.2 Languages

The supplementary description with connection examples has been drawn up in German. All other available languages are translations of the original supplementary description.

The supplementary description is available in German and English.

1.3 Other relevant documents



All documents are available online at the following addresses:

- BARTEC (global): www.bartec.de
- BARTEC (ACS): <http://automation.bartec.de>
- ZEBRA (ZEB): www.zebra.com



Where information overlaps with that in Zebra manuals, the instructions in the BARTEC User Manual apply. The BARTEC User Manual takes priority.

Document	Explanation	Download page
BARTEC		
Quick Start Guide BCS 3608 ^{ex} -NI / BCS 3608 ^{ex} -IS / BCS 3678 ^{ex} -NI / BCS 3678 ^{ex} -IS	Guidelines on commissioning and the safe use of hand-held scanners (including installation, explosion protection related safety instructions and programming instructions)	Global
User Manual BCS 3608 ^{ex} -NI / BCS 3608 ^{ex} -IS / BCS 3678 ^{ex} -NI / BCS 3678 ^{ex} -IS	Guidelines on commissioning and the safe use of hand-held scanners (including installation, explosion protection related safety instructions and programming instructions)	Global
Data sheet – BSC 3608 ^{ex} -NI / BSC 3608 ^{ex} -IS / BCS 3678 ^{ex} -NI / BSC 3678 ^{ex} -IS	Data on explosion protection and technical data for hand-held scanners	Global
ZEBRA		
For DS3608-HP und DS3678-HP: For DS3608-ER und DS3678-ER: <ul style="list-style-type: none"> • Product Reference Guide • Multicode Data Formatting and Preferred Symbol • Advanced Data Formatting (ADF) • Simple Serial Interface Programmer's Guide 	Instructions for commissioning, operating, configuring, programming and maintaining hand-held scanners (full information can be found on the ZEBRA support page.)	ZEB

2. Note

These instructions use simple examples to illustrate how a BCS36x8^{ex} series hand-held scanner can be connected to a PC. The connection examples explain which components are needed, how the connection should be performed, and which settings and programming are required.

The aim is to provide simple guidelines that anyone can use to establish and test the connection and communication/data transmission.

3. Programming Tools

There are 2 options available for programming the BCS36x8^{ex} series.

1. Programming via Barcodes.

For programming using barcodes, the original Zebras manuals can be used. With the help of the programmable codes, extensive settings can be made on the scanner.
available on:

BARTEC download page:

<http://automation.bartec.de/scanner.htm>

Zebra support download page:

<https://www.zebra.com/us/en/support-downloads.html>

- Barcode Scanners
- Ultra Rugged Scanners --- DS3608-HP/DS3678-HP; DS3608-ER/DS3678-ER
- Manuals

2. Programming via Zebra 123 Scan Utility.

The utility is a free software tool from Zebra.

It allows a simple and fast configuration of the BCS36x8^{ex} series via USB.

The configuration can either be transferred directly to the scanner via USB or alternatively, programmable codes can be generated for scanning.

available on:

Zebra support download page:

<https://www.zebra.com/us/en/support-downloads.html>

- Barcode Scanners
- Ultra Rugged Scanners --- DS3608-HP/DS3678-HP; DS3608-ER/DS3678-ER
- Utilities --- 123 Scan Utility



The Zebra 123 Scan Utility support only USB connection to the scanner.
The Utility is running on Windows operating system.



Programming / setting via the Zebra 123 Scan Utility is not supported via the Universal Power Supply Module (UVM).

A programming cable is required.



Further notes on programming can be found in the:

- BARTEC user manual.
- Original Zebra documentation. The explosion-proof BARTEC hand scanners are functionally based on the following Zebra hand scanners:
 - BCS3608ex-IS is based on Zebra DS3608-HP
 - BCS3678ex-IS is based on Zebra DS3678-HP
 - BCS3608ex-NI based on Zebra DS3608-HP or DS3608-ER
 - BCS3678ex-NI based on Zebra DS3678-HP or DS3678-ER

4. Wired BCS3608^{ex} hand-held scanner

4.1 Connection RS-422 to PC via universal supply module

4.1.1 Components required

Functional system	
BCS3608 ^{ex} -IS ATEX / IECEx Zone 1/21 NEC / CEC Class I, II, III Division 1	BCS3608 ^{ex} -NI ATEX / IECEx Zone 2/22 NEC / CEC Class I, II, III Division 2
1 x	Wired BCS3608 ^{ex} hand-held scanner
	Type: 17-A1S4-1HP0
	Type: B7-A2S4-1HP0 or B7-A2S4-1ER0
1 x	Universal supply module for hand-held scanners
	ATEX / IECEx Zone 1/21 Type: 17-A1Z0-0018
	ATEX / IECEx Zone 2/22 Type: B7-A2Z0-0042 NEC / CEC Class I, II, III Division 2 Type: B7-A2Z0-0042US
1 x	Connection cable for connection between universal supply module and scanner
	Type: 17-A1Z0-0015 or 17-A1Z0-0016 or 17-A1Z0-0017
	Type: B7-A2Z0-0037 or B7-A2Z0-0038 or B7-A2Z0-0039
To be provided by the customer	
1 x	1 x RS-422 connection cable to the host PC. Maximum cable length supported: 1000 m Number of cores and recommended cable cross section: see BARTEC User Manual. http://automation.bartec.de/scanner.htm NB: – The default setting for the hand-held scanner is as an HID device. The serial interface still needs to be activated with the help of a programming barcode. The universal supply module is then detected by the host PC as a series connection. – Please use standard, shielded data lines to prevent external disturbances. Recommendation: e.g. use CAT5, similar or higher quality cables
1 x	PC with serial (COM) interface
1 x	Terminal program or software keyboard wedge for testing virtual COM communication and data transmission on the host PC.

4.1.2 Connection

Diagram

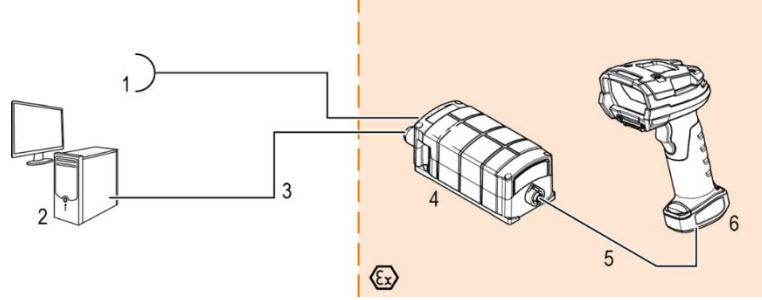

Pos.	Description
1	Power supply (100 to 240 V _{AC} ±10% / 50/60 Hz or 24 V _{DC} ±10% 0.4A) Note: NEC/CEC version only with 24V _{DC} .
2	Host PC
3	RS-422 data cable from host PC to universal supply module (max. 1000m)
4	Universal supply module for hand-held scanners
5	BCS 3608 ^{ex} connection cable
6	BCS 3608 ^{ex} hand-held scanner

Universal supply module

1 st generation with DIP switch		2 nd generation without DIP switch	
Pos.	Description	Function	
1	Cable gland	Feed data cable to terminals	
2	Cable gland	Feed power cord to terminals	
3	Terminals X1 to X2	Connect 100 to 240 V _{AC} power supply	
4	Shield clamp for ferrite core	The ferrite core is only needed when using the USB-SPP interface.	
5	Terminals X3 to X4	Connect 24 V _{DC} power supply	
6	Terminals X5 to X10	Connect RS-422 data line	
7	7-pole round plug N/A in the Bluetooth version	Plug for wired hand-held scanner	
8	Cover	Protect / seal terminal connection chamber	
9	DIP switch	Select/set used interface: 1st generation: setup via DIP switches 2nd generation: setup via barcodes	

Universal supply module – programming barcodes for interfaces

Only relevant for 2nd generation of USM without DIP switch

The programming barcodes for the interfaces are placed inside of the USM cap.

Setup of the interface:

- Connect scanner via connection cable to USM.
- Scan the RS-422 barcode to set the interface on USM.

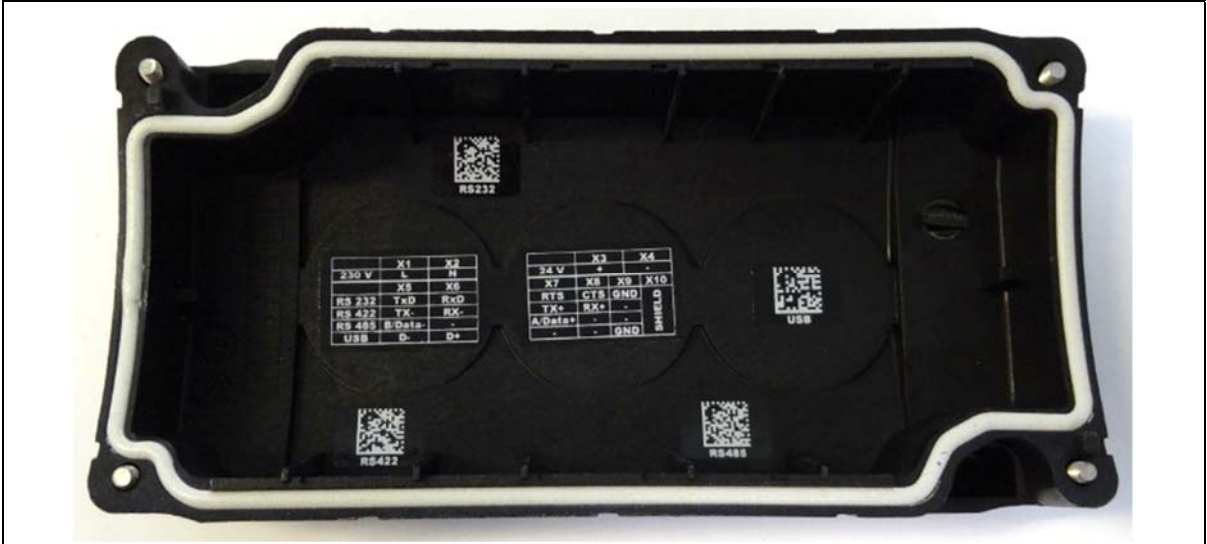

Universal supply module - terminal assignment

Terminal		Mains connection / RS-422 interface
X1	L (230V)	L = 100 V _{AC} to 240 V _{AC} ±10% / 50/60 Hz
X2	N (230V)	N = Neutral conductor
X3	+ (24V)	24 V _{DC+} ±10% / 0,4A
X4	- (24V)	24 V _{DC-} ±10% / 0,4A
X5	1	TxD-
X6	2	RxD-
X7	3	TxD+
X8	4	RxD+
X9	GND	Not mandatory (optional)
X10	SHIELD	Placing the shield

Universal supply module – 1st generation with DIP switch

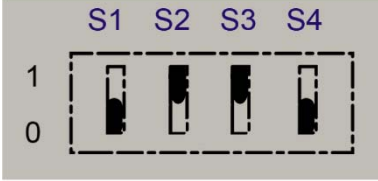
Setting					
DIP switch	Interface	S1	S2	S3	S4
	RS-422	0	1	1	0



The interface is set using DIP switches S1, S2 and S3.

DIP switch 4 is used to select whether the universal supply module is suitable for the wired or Bluetooth hand-held scanner.

S4: 0 = wired / 1 = Bluetooth

Universal supply module – 2nd generation without DIP switch

Scan the programming code for the RS-422 serial interface.



The universal supply module (USM) is already preset on the hardware side to the wired scanner version.

Universal supply module –FTDI-FT232-R driver



Driver for the universal supply module (USM).

On connecting the USM, the drivers are automatically detected by the Windows operating system and installed if necessary.

If not detected automatically, the driver can be downloaded from the BARTEC download page or directly from the FTDI website (<https://www.ftdichip.com/>) and installed manually.

The driver is compatible with:

- Windows 10, 8.1, 8, 7 --- 32/64 bit

BARTEC download page: <http://automation.bartec.de/indexE.htm>

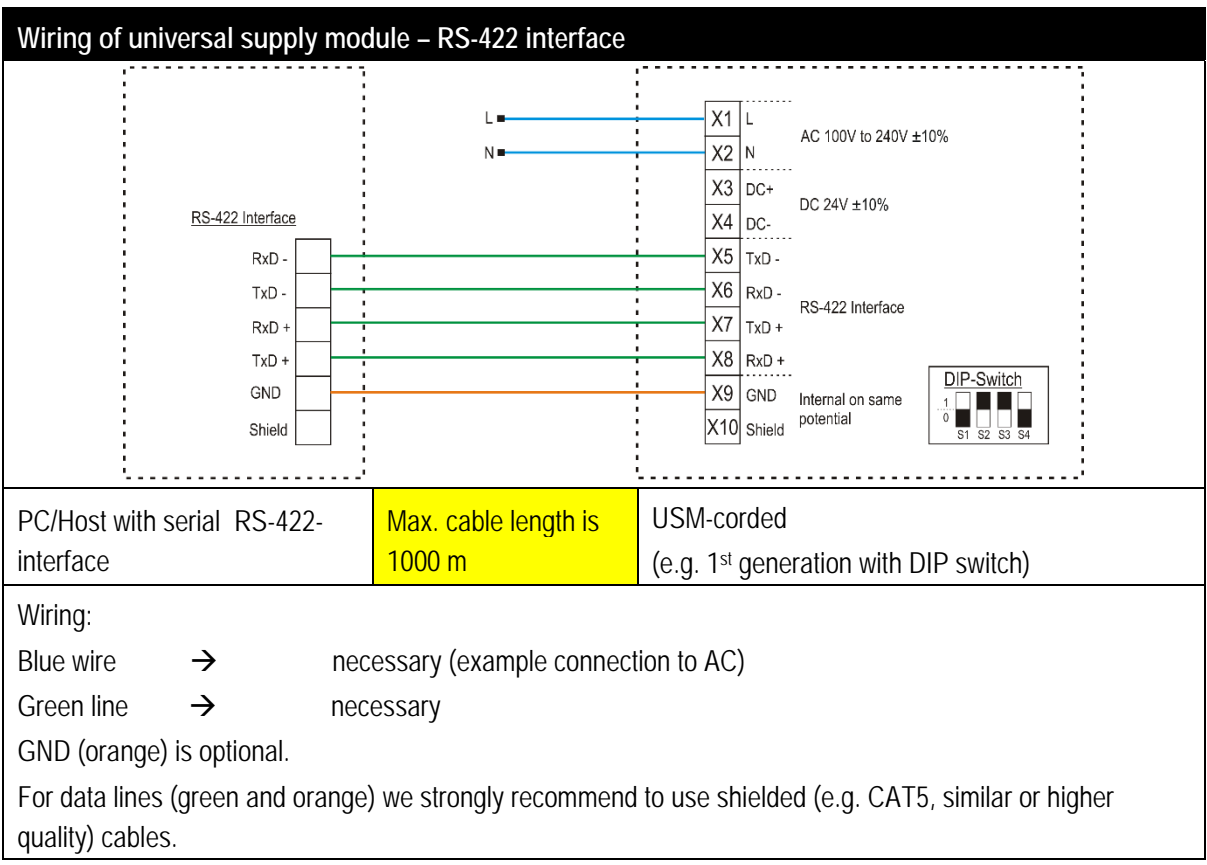

The DIP switch is only populated in the 1st generation of the USM. From the 2nd generation onwards, the interface is set via programming barcodes.

4.1.3 Setting/programming

The programming barcodes have been taken from the original Zebra Product Reference Guide (PRG).



The functions of the BCS3608^{ex} and BCS3678^{ex} are based on the Zebra DS3608-HP/DS3608-ER and DS3678-HP/DS3678-ER.

The Guide is available to download from Zebra or from BARTEC:

Zebra support download page:

<https://www.zebra.com/us/en/support-downloads.html>

- Barcode Scanners
- Ultra Rugged Scanners – DS3608-HP/DS3678-HP and DS3608-ER/DS3678-ER

BARTEC download page:

<http://automation.bartec.de/indexE.htm>

- Data capture

Function	Barcode
Set factory defaults Scan the barcode for factory settings to remove all customized defaults and set the digital scanner to factory default settings (factory defaults can be found in the Zebra PRG, <i>Appendix A, Standard Default Parameters</i>).	
Default settings	Hand-held scanner is set as HID device.
Default settings of the RS-232 interface (COM)	<u>RS-232 and (RS-422) host parameters</u> Baud rate: 9600 baud Parity: None Stop bits: 1-bit Data bits: 8-bit Hardware handshaking: None Software handshaking: None



The hand-held scanner is set as HID device as default. The serial interface still needs to be activated using a programming barcode.

Scan in the “ Standard RS-232 ” barcode to activate the serial RS-232 interface.	
---	---



Further customized settings can be performed with the help of the Zebra Product Reference Guide or the Zebra 123Scan utility.



Programming/setting via the Zebra 123 Scan Utility is not supported via the USM. A programming cable is required.

4.1.4 Testing communication/data transmission

The communication/data transmission on the host PC can be tested with the help of a terminal program or a software keyboard wedge.



A software wedge or other application must be installed on the host PC for data transmission when using a universal supply module.

The software wedge or other application is used to convert the incoming data to a keyboard entry and to enter the data into the field currently active on the host PC.

Terminal program



The test with a terminal program described below was conducted with the H-Term application. Alternatively any other terminal program that supports serial communication may be used.

Testing communication/data transmission

Open terminal program

Select serial interface to which the BCS3608^{ex} is connected (COM1 in the example).

Can be checked in the device manager.

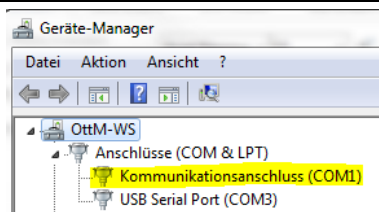

Perform settings in the terminal program and press 'Connect'.



Read barcode with scanner and check in the terminal program that the data are displayed.

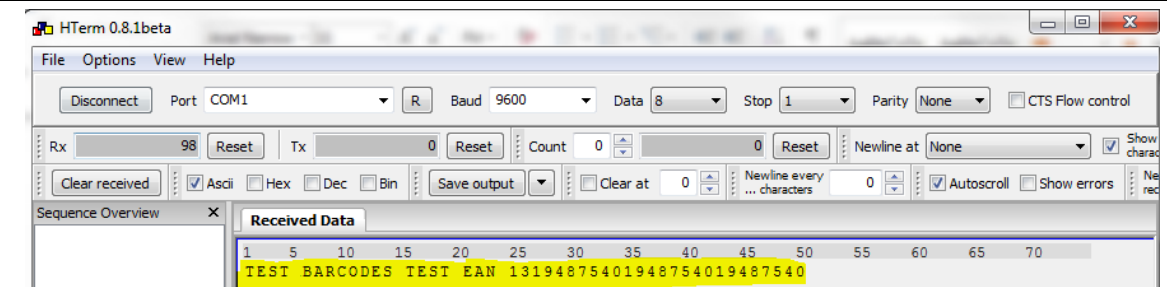

Data transmission is OK if the barcode data is displayed in the "Received Data" window.

If not, check connection and programming.

5. Bluetooth BCS3678^{ex} hand-held scanner

5.1 Connection RS-422 to PC via universal supply module

5.1.1 Components required

Functional system	
BCS3678 ^{ex} -IS ATEX / IECEx Zone 1/21 NEC / CEC Class I, II, III Division 1	BCS3678 ^{ex} -NI ATEX / IECEx Zone 2/22 NEC / CEC Class I, II, III Division 2
1 x	Bluetooth BCS3678 ^{ex} hand-held scanner
	Type: 17-A1S4-2HP1
	Type: B7-A2S4-2HP1 or B7-A2S4-2ER1
1 x	Universal supply module for hand-held scanner
	ATEX / IECEx Zone 1/21 Type: 17-A1Z0-0019
	ATEX / IECEx Zone 2/22 Type: B7-A2Z0-0043 NEC / CEC Class I, II, III Division 2 Type: B7-A2Z0-0043US
To be provided by the customer	
1 x	1 x RS-422 connection cable to the host PC Maximum cable length supported: 1000m Number of cores and recommended cable cross section: see BARTEC User Manual. http://automation.bartec.de/scanner.htm
	<u>NB:</u> – The default setting for the hand-held scanner is as HID device. The serial interface still needs to be activated with the help of a programming barcode. The universal supply module is then detected by the host PC as a series connection. – Please use standard, shielded data lines to prevent external disturbances. Recommendation: e.g. use CAT5, similar or higher quality cables
1 x	PC with serial (COM) interface
1 x	Terminal program or software keyboard wedge for testing virtual COM communication and data transmission on the host PC.

5.1.2 Connection

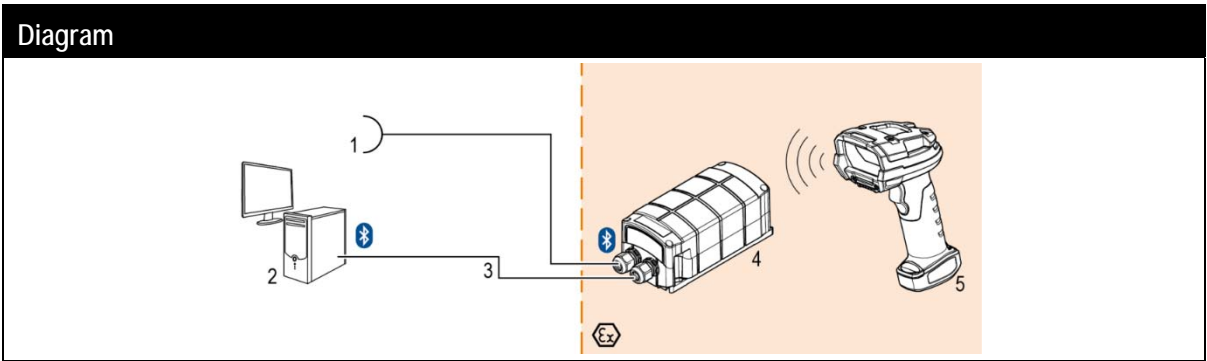

Pos.	Description
1	Power supply (100 to 240 V _{AC} ±10% / 50/60 Hz or 24 V _{DC} ±10% 0.4A) Note: NEC/CEC version only with 24V _{DC} .
2	Host PC
3	RS-422 data cable from host PC to the universal supply module (max. 15m)
4	Universal supply module for hand-held scanners
5	BCS 3678 ^{ex} hand-held scanner

Universal supply module

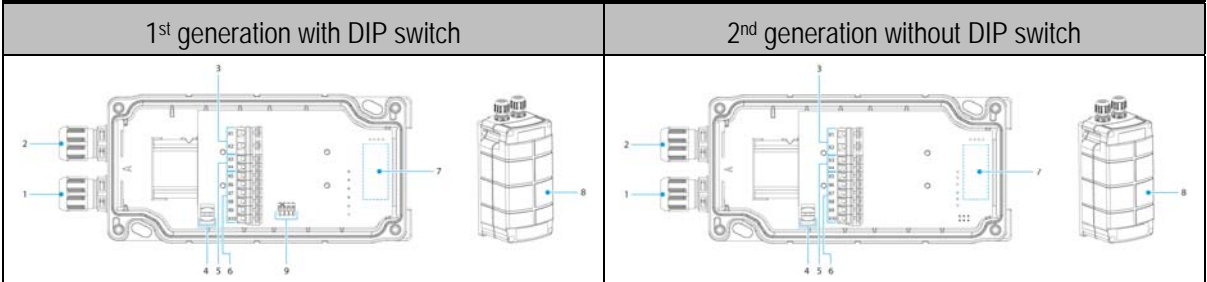

Pos.	Description	Function
1	Cable gland	Feed data cable to terminals
2	Cable gland	Feed power cord to terminals
3	Terminals X1 to X2	Connect 100 to 240 V _{AC} power supply
4	Shield clamp for ferrite core	The ferrite core is only needed when using the USB-SPP interface.
5	Terminals X3 to X4	Connect 24 V _{DC} power supply
6	Terminals X5 to X10	Connect RS-422 data line
7	Position of the Bluetooth module	Only equipped for the Bluetooth version
8	Cover	Protect / seal terminal connection chamber
9	DIP switch	Select/set used interface: 1st generation: setup via DIP switches 2nd generation: setup via barcodes

Universal supply module – programming barcodes for interfaces

Only relevant for 2nd generation of USM without DIP switch

The programming barcodes for the interfaces are placed inside of the USM cap.

Setup of the interface:

- Connect scanner via Bluetooth to USM.
- Scan the RS-422 barcode to set the interface on USM.

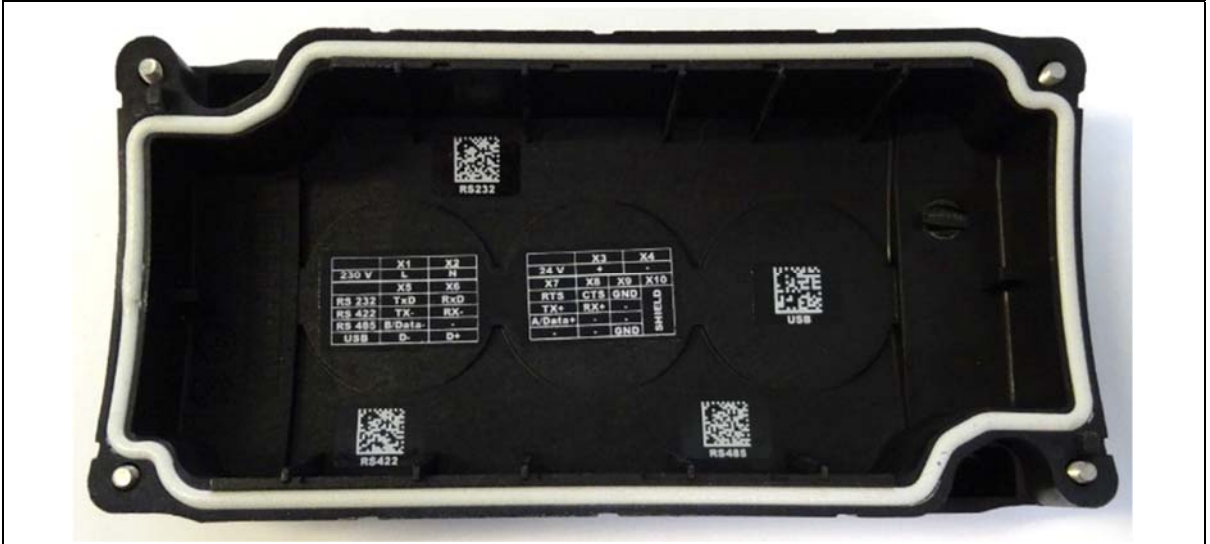

Universal supply module - terminal assignment

Terminal		Mains connection / RS-422 interface
X1	L (230V)	L = 100 V _{AC} to 240 V _{AC} ±10% / 50/60 Hz
X2	N (230V)	N = Neutral conductor
X3	+ (24V)	24 V _{DC+} ±10% / 0,4A
X4	- (24V)	24 V _{DC-} ±10% / 0,4A
X5	1	TxD-
X6	2	RxD-
X7	3	TxD+
X8	4	RxD+
X9	GND	Not mandatory
X10	SHIELD	Placing the shield

Universal supply module – 1st generation with DIP switch

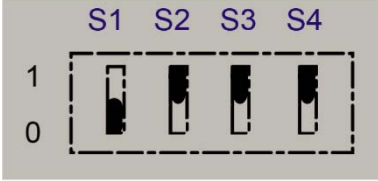
Setting					
DIP switch	Interface	S1	S2	S3	S4
	RS-422	0	1	1	1

The interface is set using DIP switches S1, S2 and S3.



DIP switch 4 is used to select whether the universal supply module is suitable for the wired or Bluetooth hand-held scanner.
 S4: 0 = wired / 1 = Bluetooth

Universal supply module – 2nd generation without DIP switch

Scan the programming code for the RS-422 serial interface.



The universal supply module (USM) is already preset on the hardware side to the Bluetooth scanner version.

Universal supply module –FTDI-FT232-R driver

Driver for the universal supply module (USM).

On connecting the USM, the drivers are automatically detected by the Windows operating system and installed if necessary.



If not detected automatically, the driver can be downloaded from the BARTEC download page or directly from the FTDI website (<https://www.ftdichip.com/>) and installed manually.

The driver is compatible with:

- Windows 10, 8.1, 8, 7 --- 32/64 bit

BARTEC download page: <http://automation.bartec.de/indexE.htm>

Wiring of universal supply module – RS-422 interface

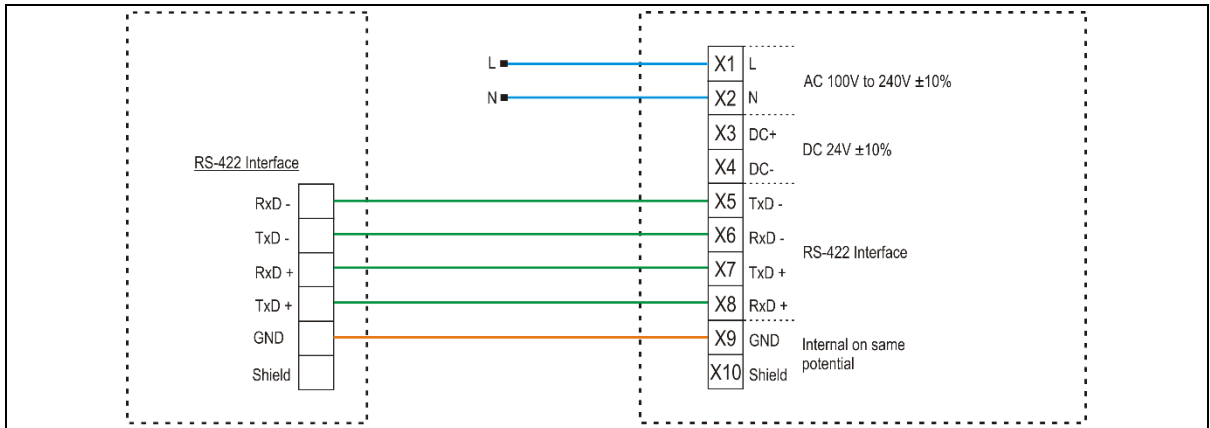

PC/Host with serial RS-422-interface	Max. cable length is 1000 m	UVM-Bluetooth (e.g. 2 nd generation without DIP switch)
<p>Wiring:</p> <p>Blue wire → necessary (example connection to AC)</p> <p>Green line → necessary</p> <p>GND (orange) is optional.</p> <p>For data lines (green and orange) we strongly recommend to use shielded (e.g. CAT5, similar or higher quality) cables.</p>		



The DIP switch is only populated in the 1st generation of the USM. From the 2nd generation onwards, the interface is set via programming barcodes.
 - Windows 10, 8.1, 8, 7 --- 32/64 bit

BARTEC download page: <http://automation.bartec.de/indexE.htm>

5.1.3 Setting/programming

The programming barcodes have been taken from the original Zebra Product Reference Guide (PRG).



The functions of the BCS3608^{ex} and BCS3678^{ex} are based on the Zebra DS3608-HP/ER and DS3678-HP/ER.

The Guide is available to download from Zebra or from BARTEC:

Zebra support download page:



<https://www.zebra.com/us/en/support-downloads.html>

- Barcode Scanners
- Ultra Rugged Scanners – DS3608-HP/DS3678-HP and DS3608-ER/DS3678-ER

BARTEC download page:

<http://automation.bartec.de/indexE.htm>

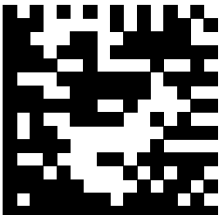
- Data capture

Function	Barcode
Set factory defaults Scan the barcode for factory settings to remove all customized defaults and set the digital scanner to factory default settings (factory defaults can be found in the Zebra PRG, <i>Appendix A, Standard Default Parameters</i>).	
Default settings	Hand-held scanner is set as HID device.
Unpairing Delete all existing Bluetooth connections.	
Prepare the scanner to pair with the universal supply module. Scan in the "Bluetooth Serial Port Profile (Master)" barcode.	

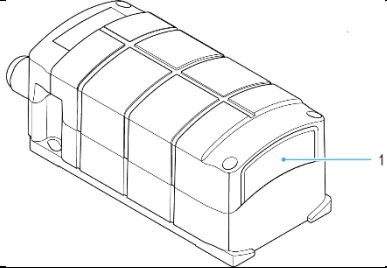

The "Bluetooth Serial Port Profile (Master)" barcode can be created at any time using the Zebra 123Scan utility.

<p>Scan in the pairing barcode on the universal supply module. The barcode can be found on the cover.</p>	
---	---

i The barcode for pairing can be created at any time using the Zebra 123Scan utility. Use the MAC address of the Bluetooth module in the universal supply module for this.

i Programming/setting via the Zebra 123 Scan Utility is not supported via the USM. A programming cable is required.

i The hand-held scanner is paired to the universal supply module via Bluetooth. The universal supply module transmits serial data on the output side. You can find the set factory defaults below.

	<u>RS-232 (RS-422) host parameters</u>	<u>RS-232 (RS-422) host parameters</u>
<p>Default settings of the Bluetooth module in the universal supply module</p>	<p>UVM 1. Generation: Baud Rate: 115200 Baud</p>	<p>UVM 2. Generation: Baud Rate: 9600 Baud</p>
	<p>Parity: None</p>	
	<p>Stop bits: 1-Bit</p>	
	<p>Data bits: 8-Bit</p>	
	<p>Hardware handshaking: None Software handshaking: None</p>	

i Further customized settings can be performed with the help of the Zebra Product Reference Guide or the Zebra 123Scan utility.

5.1.4 Testing communication/data transmission

The communication/data transmission on the host PC can be tested with the help of a terminal program or a software keyboard wedge.



A software wedge or other application must be installed on the host PC for data transmission when using a universal supply module.

The software wedge or other application is used to convert the incoming data to a keyboard entry and to enter the data into the field currently active on the host PC.

Terminal program



The test with a terminal program described below was conducted with the H-Term application. Alternatively any other terminal program that supports serial communication may be used.

Testing communication/data transmission

Open terminal program

Select serial interface to which the BCS3608^{ex} is connected (COM1 in the example).
Can be checked in the device manager.

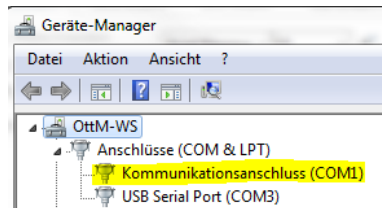

Perform settings in the terminal program and press 'Connect'.

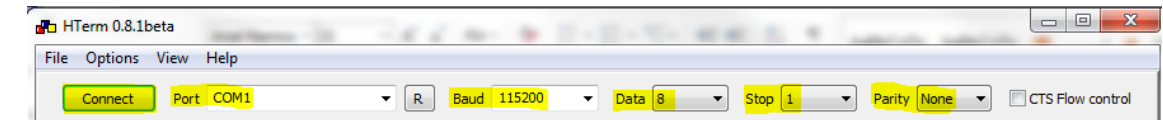

Read barcode with scanner and check in the terminal program that the data are displayed.

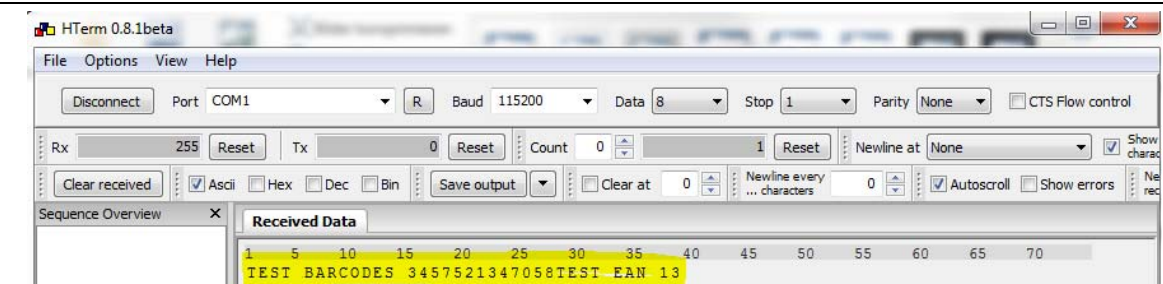

Data transmission is OK if the barcode data is displayed in the "Received Data" window.

If not, check connection and programming.