

**Supplementary description – Translation of the original
Connection examples for USB, RS232 and HID**

BCS36x8^{ex} Series

Type 17-A1S4-*HP*

ATEX / IECEx Zone 1/21

NEC / CEC Class I, II, III Division 1

Type B7-A2S4-*HP* and B7-A2S4-*ER*

ATEX / IECEx Zone 2/22

NEC / CEC Class I, II, III Division 2

Date: Rev. I / 20th September 2024

Disclaimer: We reserve the right to make technical changes. Changes, errors and misprints shall not justify any claim for damages.

Table of contents

Table of contents.....	2
1. About this documentation.....	5
1.1 Technical changes.....	5
1.2 Languages.....	5
1.3 Other relevant documents.....	6
2. Note.....	7
3. Programming Tools.....	7
4. Wired BCS3608^{ex} hand-held scanner.....	9
4.1 Connection RS232 to PC via universal supply module.....	9
4.1.1 Components required.....	9
4.1.2 Connection.....	10
4.1.3 Setting/programming.....	13
4.1.4 Testing communication/data transmission.....	14
5. Wired BCS3608^{ex} hand-held scanner.....	16
5.1 Connection USB to PC via universal supply module.....	16
5.1.1 Components required.....	16
5.1.2 Connection.....	17
5.1.3 Setting/programming.....	21
5.1.4 Testing communication/data transmission.....	22
6. Bluetooth BCS3678^{ex} hand-held scanner.....	23
6.1 Connection RS232 to PC via universal supply module.....	23
6.1.1 Components required.....	23
6.1.2 Connection.....	24
6.1.3 Setting/programming.....	27
6.1.4 Note on base station when used only for charging.....	29
6.1.5 Testing communication/data transmission.....	30
7. Bluetooth BCS3678^{ex} hand-held scanner.....	31
7.1 Connection USB to PC via universal supply module.....	31
7.1.1 Components required.....	31
7.1.2 Connection.....	32
7.1.3 Setting/programming.....	36
7.1.4 Note on base station when used only for charging.....	38
7.1.5 Testing communication/data transmission.....	39
8. Bluetooth BCS3678^{ex} hand-held scanner.....	40
8.1 Connection via cradle as HID device to host PC.....	40
8.1.1 Components required.....	40
8.1.2 Connection.....	41
8.1.3 Setting/programming.....	42
8.1.4 Testing communication/data transmission.....	43

9.	Bluetooth BCS3678^{ex} hand-held scanner	44
9.1	Connection via cradle as serial device to host PC	44
9.1.1	Components required	44
9.1.2	Connection	45
9.1.3	Setting/programming	46
9.1.4	Testing communication/data transmission.....	48
10.	Bluetooth BCS3678^{ex} hand-held scanner	49
10.1	Connection as HID device	49
10.1.1	Components required	49
10.1.2	Connection	50
10.1.3	Setting/programming	51
10.1.4	Note on base station when used only for charging.....	52
10.1.5	Testing communication/data transmission.....	53
11.	Bluetooth BCS3678^{ex} hand-held scanner	54
11.1	Connection as serial port profile (SPP) device	54
11.1.1	Components required	54
11.1.2	Connection	55
11.1.3	Setting/programming	56
11.1.4	Note on base station when used only for charging.....	57
11.1.5	Testing communication/data transmission.....	58
12.	Supply Module Ex i with BCS3608^{ex} hand-held scanner	60
12.1	Connection RS232 via supply module Ex i – type: 17-A1Z0-0025 (e.g. on Ex-HMI).....	60
12.1.1	Components required	60
12.1.2	Connection	61
12.1.3	Setting/programming	64
12.1.4	Testing communication/data transmission.....	65
13.	Supply module Ex i with BCS3608^{ex} hand-held scanner.....	67
13.1	Connection USB via supply module Ex i - type: 17-A1Z0-0025 (e.g. on Ex-HMI).....	67
13.1.1	Components required	67
13.1.2	Connection	68
13.1.3	Setting/programming	72
13.1.4	Testing communication/data transmission.....	73
14.	Supply module Ex i BT with BCS3678^{ex} hand-held scanner	74
14.1	Connection RS232 via supply module Ex i BT – type: 17-A1Z0-0028 (e.g. on Ex-HMI)	74
14.1.1	Components required	74
14.1.2	Connection	75
14.1.3	Setting/programming	78
14.1.4	Note on base station when used only for charging.....	80
14.1.5	Testing communication/data transmission.....	81
15.	Supply module Ex i BT with BCS3678^{ex} hand-held scanner	82
15.1	Connection USB via supply module Ex i BT – type: 17-A1Z0-0028 (e.g. on Ex-HMI)	82
15.1.1	Components required	82
15.1.2	Connection	83
15.1.3	Setting/programming	87
15.1.4	Note on base station when used only for charging.....	89
15.1.5	Testing communication/data transmission.....	90

16.	Wired BCS3608^{ex} hand-held scanner with HMI limiting cable	91
16.1	Connection USB limiting cable (e.g. on Ex-HMI).....	91
16.1.1	Components required	91
16.1.2	Connection	92
16.1.3	Setting/programming	93
16.1.4	Testing communication/data transmission.....	94

1. About this documentation



Read carefully before commissioning the device.

This manual with connection examples is a supplementary description to the BARTEC User Manual.

This manual is aimed at all persons entrusted with using the device.

It is essential to know about and strictly comply with the safety signs and warnings in the BARTEC User Manual.

- Read the User Manual, in particular the safety instructions, carefully before using the device.
- Keep the User Manual for the entire service life of the device.
- Make the User Manual accessible to all those who are entrusted with using the device.

1.1 Technical changes

The current versions of data sheets, manuals, certificates and EC declarations of conformity as well as information about new accessories can be downloaded from www.bartec.de under “Products & solutions” in the “Automation technology” product area, or can be requested directly from BARTEC GmbH.

1.2 Languages

The supplementary description with connection examples has been drawn up in German. All other available languages are translations of the original supplementary description.

The supplementary description is available in German and English.

1.3 Other relevant documents



All documents are available online at the following addresses:

- BARTEC (global): www.bartec.de
- BARTEC (ACS): <http://automation.bartec.de>
- ZEBRA (ZEB): www.zebra.com



Where information overlaps with that in Zebra manuals, the instructions in the BARTEC User Manual apply. The BARTEC User Manual takes priority.

Document	Explanation	Download page
BARTEC		
Quick Start Guide BCS 3608 ^{ex} -NI / BCS 3608 ^{ex} -IS / BCS 3678 ^{ex} -NI / BCS 3678 ^{ex} -IS	Guidelines on commissioning and the safe use of hand-held scanners (including installation, explosion protection related safety instructions and programming instructions)	Global
User Manual BCS 3608 ^{ex} -NI / BCS 3608 ^{ex} -IS / BCS 3678 ^{ex} -NI / BCS 3678 ^{ex} -IS	Guidelines on commissioning and the safe use of hand-held scanners (including installation, explosion protection related safety instructions and programming instructions)	Global
Data sheet – BSC 3608 ^{ex} -NI / BSC 3608 ^{ex} -IS / BCS 3678 ^{ex} -NI / BSC 3678 ^{ex} -IS	Data on explosion protection and technical data for hand-held scanners	Global
ZEBRA		
For DS3608-HP und DS3678-HP: For DS3608-ER und DS3678-ER: <ul style="list-style-type: none"> • Product Reference Guide • Multicode Data Formatting and Preferred Symbol • Advanced Data Formatting (ADF) • Simple Serial Interface Programmer's Guide 	Instructions for commissioning, operating, configuring, programming and maintaining hand-held scanners (full information can be found on the ZEBRA support page.)	ZEB

2. Note

These instructions use simple examples to illustrate how a BCS36x8^{ex} series hand-held scanner can be connected to a PC. The connection examples explain which components are needed, how the connection should be performed, and which settings and programming are required.

The aim is to provide simple guidelines that anyone can use to establish and test the connection and communication/data transmission.

3. Programming Tools

There are 2 options available for programming the BCS36x8^{ex} series.

1. Programming via Barcodes.

For programming using barcodes, the original Zebras manuals can be used. With the help of the programmable codes, extensive settings can be made on the scanner.
available on:

BARTEC download page:

<http://automation.bartec.de/scanner.htm>

Zebra support download page:

<https://www.zebra.com/us/en/support-downloads.html>

- Barcode Scanners
- Ultra Rugged Scanners --- DS3608-HP/DS3678-HP; DS3608-ER/DS3678-ER
- Manuals

2. Programming via Zebra 123 Scan Utility.

The utility is a free software tool from Zebra.

It allows a simple and fast configuration of the BCS36x8^{ex} series via USB.

The configuration can either be transferred directly to the scanner via USB or alternatively, programmable codes can be generated for scanning.

available on:

Zebra support download page:

<https://www.zebra.com/us/en/support-downloads.html>

- Barcode Scanners
- Ultra Rugged Scanners --- DS3608-HP/DS3678-HP; DS3608-ER/DS3678-ER
- Utilities --- 123 Scan Utility



The Zebra 123 Scan Utility support only USB connection to the scanner.
The Utility is running on Windows operating system.



Programming / setting via the Zebra 123 Scan Utility is not supported via the Universal Power Supply Module (UVM).

A programming cable is required.



Further notes on programming can be found in the:

- BARTEC user manual.
- Original Zebra documentation. The explosion-proof BARTEC hand scanners are functionally based on the following Zebra hand scanners:
 - BCS3608ex-IS is based on Zebra DS3608-HP
 - BCS3678ex-IS is based on Zebra DS3678-HP
 - BCS3608ex-NI based on Zebra DS3608-HP or DS3608-ER
 - BCS3678ex-NI based on Zebra DS3678-HP or DS3678-ER

4. Wired BCS3608^{ex} hand-held scanner

4.1 Connection RS232 to PC via universal supply module

4.1.1 Components required

Functional system	
BCS3608^{ex}-IS ATEX / IECEx Zone 1/21 NEC / CEC Class I, II, III Division 1	BCS3608^{ex}-NI ATEX / IECEx Zone 2/22 NEC / CEC Class I, II, III Division 2
1 x	Wired BCS3608 ^{ex} hand-held scanner
	Type: 17-A1S4-1HP0
	Type: B7-A2S4-1HP0 or B7-A2S4-1ER0
1 x	Universal supply module for hand-held scanners
	ATEX / IECEx Zone 1/21 Type: 17-A1Z0-0018
	ATEX / IECEx Zone 2/22 Type: B7-A2Z0-0042 NEC / CEC Class I, II, III Division 2 Type: B7-A2Z0-0042US
1 x	Connection cable for connection between universal supply module and scanner
	Type: 17-A1Z0-0015 or 17-A1Z0-0016 or 17-A1Z0-0017
	Type: B7-A2Z0-0037 or B7-A2Z0-0038 or B7-A2Z0-0039
To be provided by the customer	
1 x	1 x RS232 connection cable to the host PC. Maximum cable length supported: 15 m Number of cores and recommended cable cross section: see BARTEC User Manual. http://automation.bartec.de/scanner.htm NB: – The default setting for the hand-held scanner is as an HID device. The serial interface still needs to be activated with the help of a programming barcode. The universal supply module is then detected by the host PC as a series connection. – Please use standard, shielded data lines to prevent external disturbances. Recommendation: e.g. use CAT5, similar or higher quality cables
1 x	PC with serial (COM) interface
1 x	Terminal program or software keyboard wedge for testing virtual COM communication and data transmission on the host PC.

4.1.2 Connection

Diagram

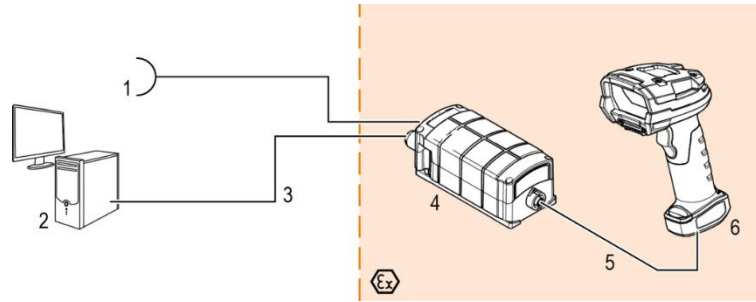

Pos.	Description
1	Power supply (100 to 240 V _{AC} ±10% / 50/60 Hz or 24 V _{DC} ±10% 0.4A) Note: NEC/CEC version only with 24V _{DC} .
2	Host PC
3	RS232 data cable from host PC to universal supply module (max. 15m)
4	Universal supply module for hand-held scanners
5	BCS 3608 ^{ex} connection cable
6	BCS 3608 ^{ex} hand-held scanner

Universal supply module

1 st generation with DIP switch		2 nd generation without DIP switch	
Pos.	Description	Function	
1	Cable gland	Feed data cable to terminals	
2	Cable gland	Feed power cord to terminals	
3	Terminals X1 to X2	Connect 100 to 240 V _{AC} power supply	
4	Shield clamp for ferrite core	The ferrite core is only needed when using the USB-SPP interface.	
5	Terminals X3 to X4	Connect 24 V _{DC} power supply	
6	Terminals X5 to X9	Connect RS232 data line	
7	7-pole round plug N/A in the Bluetooth version	Plug for wired hand-held scanner	
8	Cover	Protect / seal terminal connection chamber	
9	DIP switch	Select/set used interface: 1st generation: setup via DIP switches 2nd generation: setup via barcodes	

Universal supply module - terminal assignment

Terminal		Mains connection / RS232 interface
X1	L (230V)	L = 100 V _{AC} to 240 V _{AC} ±10% / 50/60 Hz
X2	N (230V)	N = Neutral conductor
X3	+ (24V)	24 V _{DC+} ±10% / 0,4A
X4	- (24V)	24 V _{DC-} ±10% / 0,4A
X5	1	TxD
X6	2	RxD
X7	3	RTS
X8	4	CTS
X9	GND	GND
X10	SHIELD	Placing the shield

Universal supply module – 1st generation with DIP switch

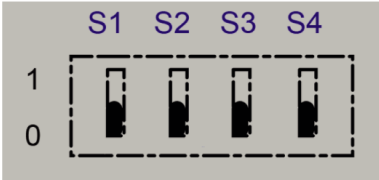
Setting					
DIP switch	Interface	S1	S2	S3	S4
	RS232	0	0	0	0



The interface is set using DIP switches S1, S2 and S3.

DIP switch 4 is used to select whether the universal supply module is suitable for the wired or Bluetooth hand-held scanner.

S4: 0 = wired / 1 = Bluetooth

Universal supply module – 2nd generation without DIP switch

Scan the programming code for the RS232 serial interface.	 RS232
---	---



The universal supply module (USM) is already preset on the hardware side to the wired scanner version.

Universal supply module –FTDI-FT232-R driver

Driver for the universal supply module (USM).

On connecting the USM, the drivers are automatically detected by the Windows operating system and installed if necessary.



If not detected automatically, the driver can be downloaded from the BARTEC download page or directly from the FTDI website (<https://www.ftdichip.com/>) and installed manually.

The driver is compatible with:

- Windows 10, 8.1, 8, 7 --- 32/64 bit

BARTEC download page: <http://automation.bartec.de/indexE.htm>

Wiring of universal supply module – RS232 interface

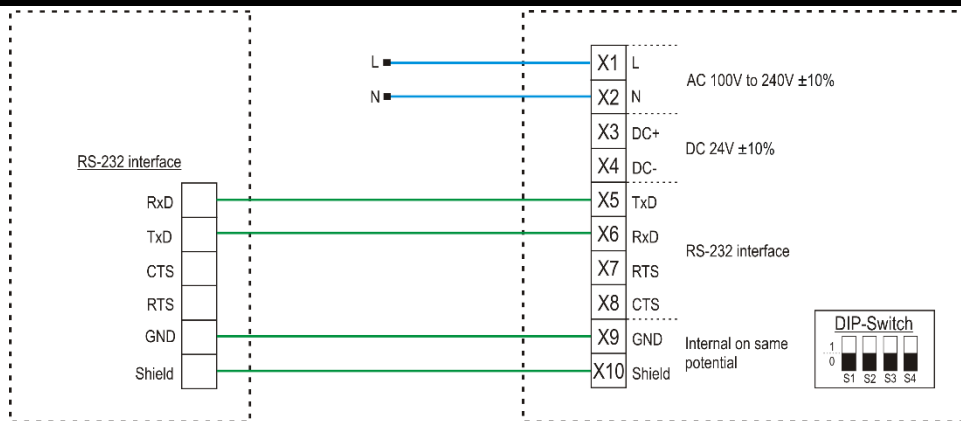

PC/Host with serial RS232-
interface

Max. cable length is
15 m

USM-corded
(e.g. 1st generation with DIP switch)

Wiring:

Blue wire → necessary (example connection to AC)

Green line → necessary

The signals RTS and CTS are not in use/no function internally. The terminals can only be used to connect the wires.

For data lines (green and orange) we strongly recommend to use shielded (e.g. CAT5, similar or higher quality) cables.



The DIP switch is only populated in the 1st generation of the USM. From the 2nd generation onwards, the interface is set via programming barcodes.

4.1.3 Setting/programming

The programming barcodes have been taken from the original Zebra Product Reference Guide (PRG).



The functions of the BCS3608^{ex} and BCS3678^{ex} are based on the Zebra DS3608-HP/DS3608-ER and DS3678-HP/DS3678-ER.

The Guide is available to download from Zebra or from BARTEC:

Zebra support download page:

<https://www.zebra.com/us/en/support-downloads.html>

- Barcode Scanners
- Ultra Rugged Scanners – DS3608-HP/DS3678-HP and DS3608-ER/DS3678-ER

BARTEC download page:

<http://automation.bartec.de/indexE.htm>

- Data capture

Function	Barcode
<p>Set factory defaults Scan the barcode for factory settings to remove all customized defaults and set the digital scanner to factory default settings (factory defaults can be found in the Zebra PRG, <i>Appendix A, Standard Default Parameters</i>).</p>	
<p>Default settings</p>	<p>Hand-held scanner is set as HID device.</p>
<p>Default settings of the RS232 interface (COM)</p>	<p><u>RS-232 host parameters</u></p> <p>Baud rate: 9600 baud Parity: None Stop bits: 1-bit Data bits: 8-bit Hardware handshaking: None Software handshaking: None</p>



The hand-held scanner is set as HID device as default. The serial interface still needs to be activated using a programming barcode.

<p>Scan in the “Standard RS-232” barcode to activate the serial RS232 interface.</p>	
---	---



Further customized settings can be performed with the help of the Zebra Product Reference Guide or the Zebra 123Scan utility.



Programming/setting via the Zebra 123 Scan Utility is not supported via the USM. A programming cable is required.

4.1.4 Testing communication/data transmission

The communication/data transmission on the host PC can be tested with the help of a terminal program or a software keyboard wedge.



A software wedge or other application must be installed on the host PC for data transmission when using a universal supply module. The software wedge or other application is used to convert the incoming data to a keyboard entry and to enter the data into the field currently active on the host PC.

Terminal program



The test with a terminal program described below was conducted with the H-Term application. Alternatively any other terminal program that supports serial communication may be used.

Testing communication/data transmission

Open terminal program

Select serial interface to which the BCS3608^{ex} is connected (COM1 in the example).

Can be checked in the device manager.

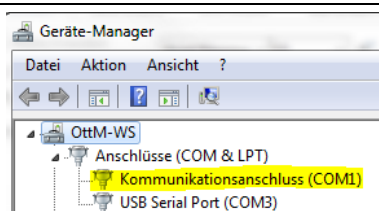

Perform settings in the terminal program and press 'Connect'.

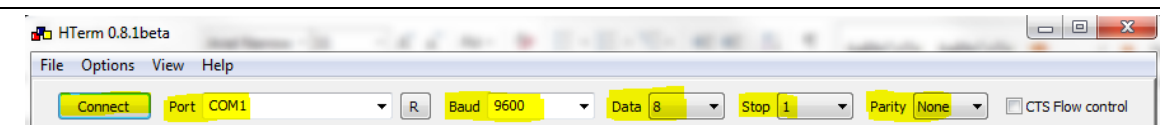

Read barcode with scanner and check in the terminal program that the data are displayed.

BCS36x8^{ex} Series Connection example
Type 17-A1S4-^{*}HP^{*} and B7-A2S4-^{**}**

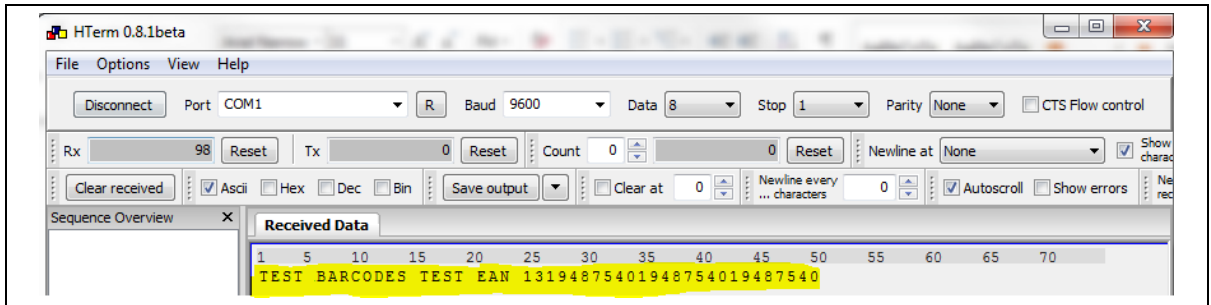

Data transmission is OK if the barcode data is displayed in the "Received Data" window.
If not, check connection and programming.

5. Wired BCS3608^{ex} hand-held scanner

5.1 Connection USB to PC via universal supply module

5.1.1 Components required

Functional system	
BCS3608^{ex}-IS ATEX / IECEx Zone 1/21 NEC / CEC Class I, II, III Division 1	BCS3608^{ex}-NI ATEX / IECEx Zone 2/22 NEC / CEC Class I, II, III Division 2
1 x	Wired BCS3608 ^{ex} hand-held scanner
	Type: 17-A1S4-1HP0
	Type: B7-A2S4-1HP0 or B7-A2S4-1ER0
1 x	Universal supply module for hand-held scanners
	ATEX / IECEx Zone 1/21 Type: 17-A1Z0-0018
	ATEX / IECEx Zone 2/22 Type: B7-A2Z0-0042 NEC / CEC Class I, II, III Division 2 Type: B7-A2Z0-0042US
1 x	Connection cable for connection between universal supply module and scanner
	Type: 17-A1Z0-0015 or 17-A1Z0-0016 or 17-A1Z0-0017
	Type: B7-A2Z0-0037 or B7-A2Z0-0038 or B7-A2Z0-0039
To be provided by the customer	
1 x	1 x USB connection cable to the host PC Maximum cable length supported: 5 m Number of cores and recommended cable cross section: see BARTEC User Manual. http://automation.bartec.de/scanner.htm NB: – USB only functions as SPP (Serial Port Profile), HID is not supported. The universal supply module is detected by the host PC as a serial connection (virtual COM interface) – Please use standard, shielded data lines to prevent external disturbances. Recommendation: e.g. use CAT5, similar or higher quality cables
1 x	PC with USB 2.0 or USB 3.0 interface
1 x	Terminal program or software keyboard wedge for testing virtual COM communication and data transmission on the host PC.

5.1.2 Connection

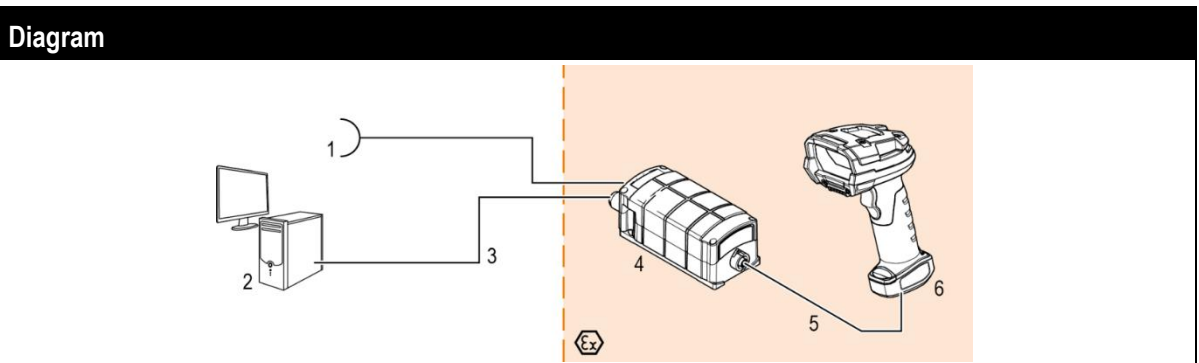

Pos.	Description
1	Power supply (100 to 240 V _{AC} ±10% / 50/60 Hz or 24 V _{DC} ±10% 0.4A) Note: NEC/CEC version only with 24V _{DC} .
2	Host PC
3	USB data cable from host PC to universal supply module (max. 5m)
4	Universal supply module for hand-held scanners
5	BCS 3608 ^{ex} connection cable
6	BCS 3608 ^{ex} hand-held scanner

Universal supply module

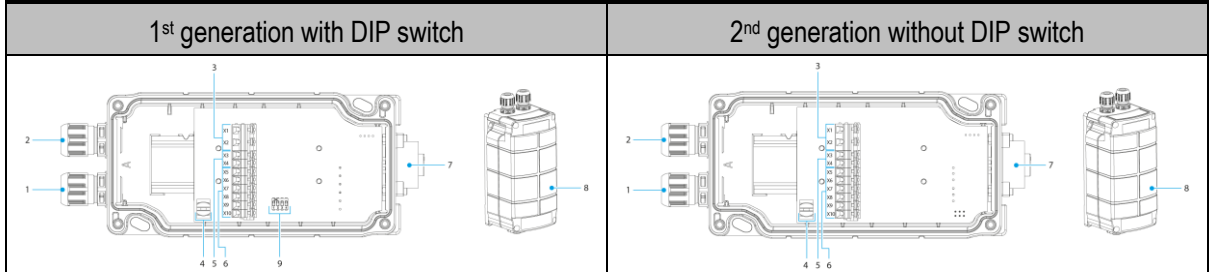

Pos.	Description	Function
1	Cable gland	Feed data cable to terminals
2	Cable gland	Feed power cord to terminals
3	Terminals X1 to X2	Connect 100 to 240 V _{AC} power supply
4	Shield clamp for ferrite core	The ferrite core is only needed when using the USB-SPP interface.
5	Terminals X3 to X4	Connect 24 V _{DC} power supply
6	Terminals X5 to X9	Connect USB-SPP data line
7	7-pole round plug N/A in the Bluetooth version	Plug for wired hand-held scanner
8	Cover	Protect / seal terminal connection chamber
9	DIP switch	Select/set used interface: 1st generation: setup via DIP switches 2nd generation: setup via barcodes

Universal supply module - terminal assignment		
Terminal	Mains connection / USB interface	
X1	L (230V)	L = 100 V _{AC} to 240 V _{AC} ±10% / 50/60 Hz
X2	N (230V)	N = Neutral conductor
X3	+ (24V)	24 V _{DC+} ±10% / 0.4A
X4	- (24V)	24 V _{DC-} ±10% / 0.4A
X5	1	Data- (D-)
X6	2	Data+ (D+)
X7	3	-
X8	4	-
X9	GND	GND
X10	SHIELD	Placing the shield

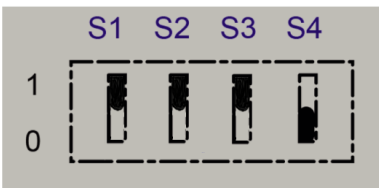
Universal supply module – 1 st generation with DIP switch					
Setting					
DIP switch	Interface	S1	S2	S3	S4
	USB-SPP	1	1	1	0

i The interface is set using DIP switches S1, S2 and S3.
 DIP switch 4 is used to select whether the universal supply module is suitable for the wired or Bluetooth hand-held scanner.
 S4: 0 = wired / 1 = Bluetooth

Universal supply module – 2 nd generation without DIP switch	
Scan the programming code for the USB-SPP virtual serial interface.	 USB-SPP

i The universal supply module (USM) is already preset on the hardware side to the wired scanner version.

Universal supply module –FTDI-FT232-R driver

Driver for the universal supply module (USM).

On connecting the USM, the drivers are automatically detected by the Windows operating system and installed if necessary.



If not detected automatically, the driver can be downloaded from the BARTEC download page or directly from the FTDI website (<https://www.ftdichip.com/>) and installed manually.

The driver is compatible with:

- Windows 10, 8.1, 8, 7 --- 32/64 bit

BARTEC download page: <http://automation.bartec.de/indexE.htm>

Wiring of universal supply module – USB-SPP interface

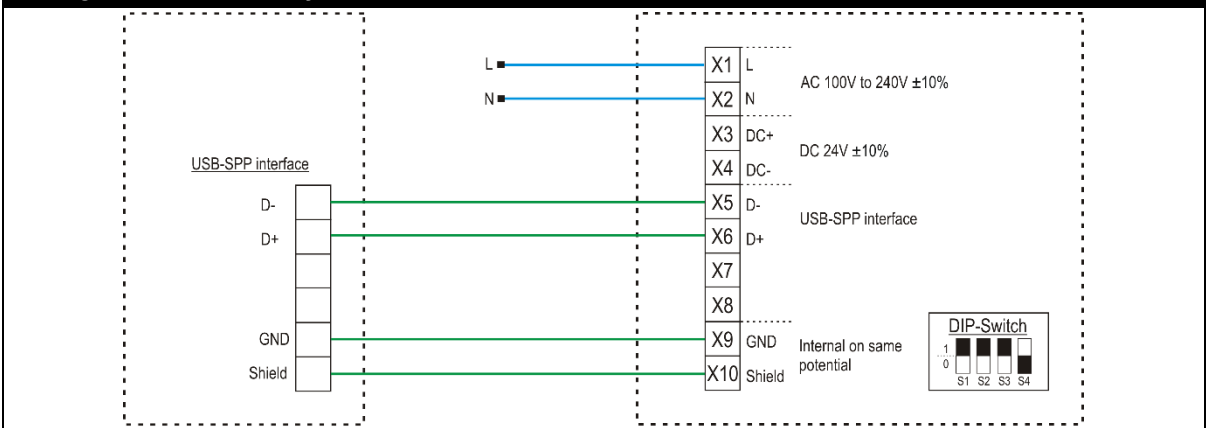

PC/Host with USB Interface USB-SPP = Serial Port Profile USB = virtual serial COM port	Max. cable length is 5 m	UVM-corded (e.g. 1st generation with DIP switch)
--	--------------------------	---

Wiring:
 Blue wire → necessary (example connection to AC)
 Green line → necessary
 For data lines (green) we strongly recommend to use shielded (e.g. CAT5, similar or higher quality) cables.



The DIP switch is only populated in the 1st generation of the USM. From the 2nd generation onwards, the interface is set via programming barcodes.

Ferrite core for data line (only when using the USB-SPP interface)

On delivery, a plastic bag with a ferrite core is included in each supply module.



The ferrite core is only required when using the USB-SPP interface.
It is used for shielding and to avoid external interference on the data line.

The ferrite core must be attached as follows.

- Strip the data line
- Slide the ferrite core over the data line
- Place data line with bare shield in the shield terminal (on the board)
- Place the data line on the terminal strip.

Ferrite core for shielding external interference signals

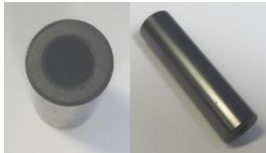

Installation in a supply module

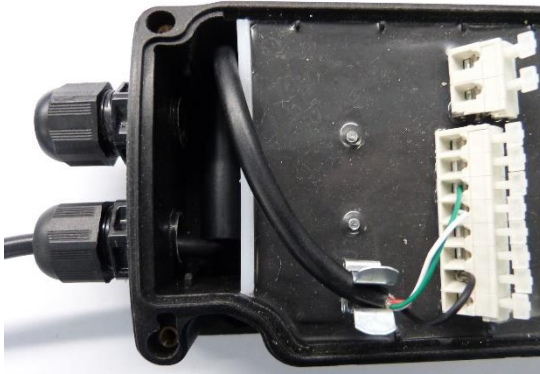

5.1.3 Setting/programming

The programming barcodes have been taken from the original Zebra Product Reference Guide (PRG).



The functions of the BCS3608^{ex} and BCS3678^{ex} are based on the Zebra DS3608-HP and DS3678-HP.

The Guide is available to download from Zebra or from BARTEC:

Zebra support download page:

<https://www.zebra.com/us/en/support-downloads.html>

- Barcode Scanners
- Ultra Rugged Scanners – DS3608-HP/DS3678-HP and DS3608-ER/DS3678-ER

BARTEC download page:

<http://automation.bartec.de/indexE>

- Data capture

Function	Barcode
<p>Set factory defaults Scan the barcode for factory settings to remove all customized defaults and set the digital scanner to factory default settings (factory defaults can be found in the Zebra PRG, Appendix A, Standard Default Parameters).</p>	
<p>Default settings</p>	<p>Hand-held scanner is set as HID device.</p>
<p>Default settings of the USB interface (virtual COM)</p>	<p><u>RS-232 host parameters</u></p> <p>Baud rate: 9600 baud</p> <p>Parity: None</p> <p>Stop bits: 1-bit</p> <p>Data bits: 8-bit</p> <p>Hardware handshaking: None</p> <p>Software handshaking: None</p>



USB functions only as SPP (Serial Port Profile), HID is not supported.
 The universal supply module is detected by the host PC as a serial connection (virtual COM interface)



Further customized settings can be performed with the help of the Zebra Product Reference Guide or the Zebra 123Scan utility.



Programming/setting via the Zebra 123 Scan Utility is not supported via the USM.
 A programming cable is required.

5.1.4 Testing communication/data transmission

The communication/data transmission on the host PC can be tested with the help of a terminal program or a software keyboard wedge.



A software wedge or other application must be installed on the host PC for data transmission when using a universal supply module.

The software wedge or other application is used to convert the incoming data to a keyboard entry and to enter the data into the field currently active on the host PC.

Terminal program



The test with a terminal program described below was conducted with the H-Term application. Alternatively any other terminal program that supports serial communication may be used.

Testing communication/data transmission

Open terminal program

Select serial interface to which the BCS3608^{ex} is connected (COM6 in the example).

Can be checked in the device manager.

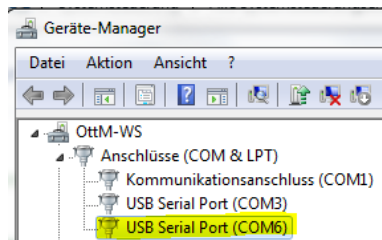

Perform settings in the terminal program and press 'Connect'.

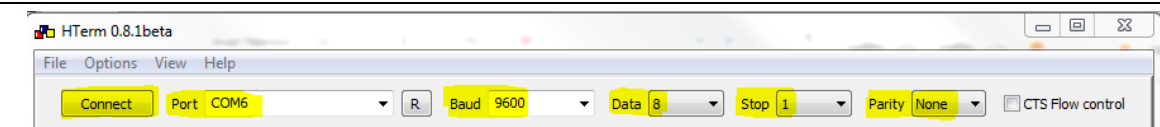

Read barcode with scanner and check in the terminal program that the data are displayed.

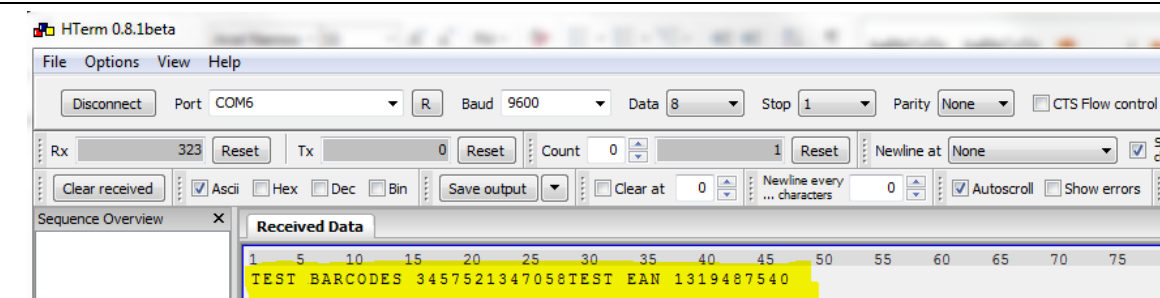

Data transmission is OK if the barcode data is displayed in the "Received Data" window.

If not, check connection and programming.

6. Bluetooth BCS3678^{ex} hand-held scanner

6.1 Connection RS232 to PC via universal supply module

6.1.1 Components required

Functional system	
BCS3678 ^{ex} -IS	BCS3678 ^{ex} -NI
ATEX / IECEx Zone 1/21 NEC / CEC Class I, II, III Division 1	ATEX / IECEx Zone 2/22 NEC / CEC Class I, II, III Division 2
1 x	Bluetooth BCS3678 ^{ex} hand-held scanner
	Type: 17-A1S4-2HP1
	Type: B7-A2S4-2HP1 or B7-A2S4-2ER1
1 x	Universal supply module for hand-held scanner
	ATEX / IECEx Zone 1/21 Type: 17-A1Z0-0019
	ATEX / IECEx Zone 2/22 Type: B7-A2Z0-0043 NEC / CEC Class I, II, III Division 2 Type: B7-A2Z0-0043US
To be provided by the customer	
1 x	1 x RS232 connection cable to the host PC Maximum cable length supported: 15m Number of cores and recommended cable cross section: see BARTEC User Manual. http://automation.bartec.de/scanner.htm
	<u>NB:</u> – The default setting for the hand-held scanner is as HID device. The serial interface still needs to be activated with the help of a programming barcode. The universal supply module is then detected by the host PC as a series connection. – Please use standard, shielded data lines to prevent external disturbances. Recommendation: e.g. use CAT5, similar or higher quality cables
1 x	PC with serial (COM) interface
1 x	Terminal program or software keyboard wedge for testing virtual COM communication and data transmission on the host PC.

6.1.2 Connection

Diagram

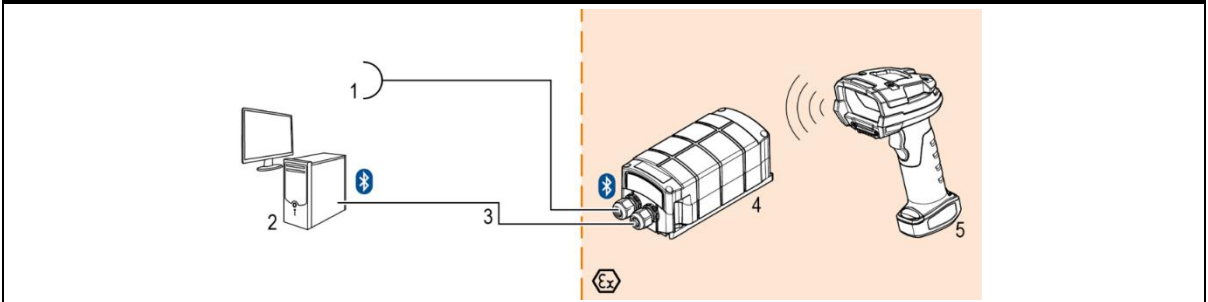

Pos.	Description
1	Power supply (100 to 240 V _{AC} ±10% / 50/60 Hz or 24 V _{DC} ±10% 0.4A) Note: NEC/CEC version only with 24V _{DC} .
2	Host PC
3	RS232 data cable from host PC to the universal supply module (max. 15m)
4	Universal supply module for hand-held scanners
5	BCS 3678 ^{ex} hand-held scanner

Universal supply module

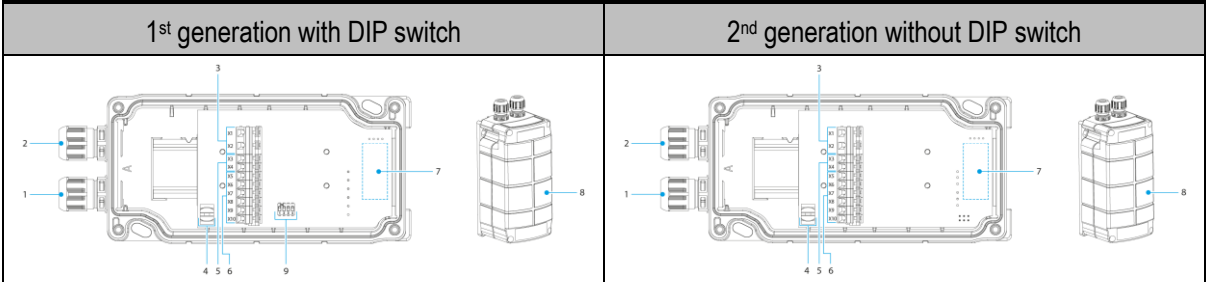

Pos.	Description	Function
1	Cable gland	Feed data cable to terminals
2	Cable gland	Feed power cord to terminals
3	Terminals X1 to X2	Connect 100 to 240 V _{AC} power supply
4	Shield clamp for ferrite core	The ferrite core is only needed when using the USB-SPP interface.
5	Terminals X3 to X4	Connect 24 V _{DC} power supply
6	Terminals X5 to X9	Connect RS232 data line
7	Position of the Bluetooth module	Only equipped for the Bluetooth version
8	Cover	Protect / seal terminal connection chamber
9	DIP switch	Select/set used interface: 1st generation: setup via DIP switches 2nd generation: setup via barcodes

Universal supply module - terminal assignment		
Terminal	Mains connection / RS232 interface	
X1	L (230V)	L = 100 V _{AC} to 240 V _{AC} ±10% / 50/60 Hz
X2	N (230V)	N = Neutral conductor
X3	+ (24V)	24 V _{DC+} ±10% / 0,4A
X4	- (24V)	24 V _{DC-} ±10% / 0,4A
X5	1	TxD
X6	2	RxD
X7	3	RTS
X8	4	CTS
X9	GND	GND
X10	SHIELD	Placing the shield

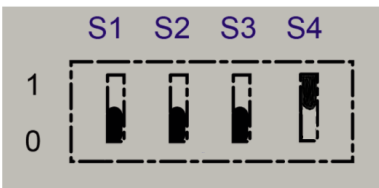
Universal supply module – 1 st generation with DIP switch					
Setting					
DIP switch	Interface	S1	S2	S3	S4
	RS232	0	0	0	1



The interface is set using DIP switches S1, S2 and S3.

DIP switch 4 is used to select whether the universal supply module is suitable for the wired or Bluetooth hand-held scanner.

S4: 0 = wired / 1 = Bluetooth

Universal supply module – 2 nd generation without DIP switch	
Scan the programming code for the RS232 serial interface.	 RS232



The universal supply module (USM) is already preset on the hardware side to the Bluetooth scanner version.

Universal supply module –FTDI-FT232-R driver

Driver for the universal supply module (USM).

On connecting the USM, the drivers are automatically detected by the Windows operating system and installed if necessary.



If not detected automatically, the driver can be downloaded from the BARTEC download page or directly from the FTDI website (<https://www.ftdichip.com/>) and installed manually.

The driver is compatible with:

- Windows 10, 8.1, 8, 7 --- 32/64 bit

BARTEC download page: <http://automation.bartec.de/indexE.htm>

Wiring of universal supply module – RS232 interface

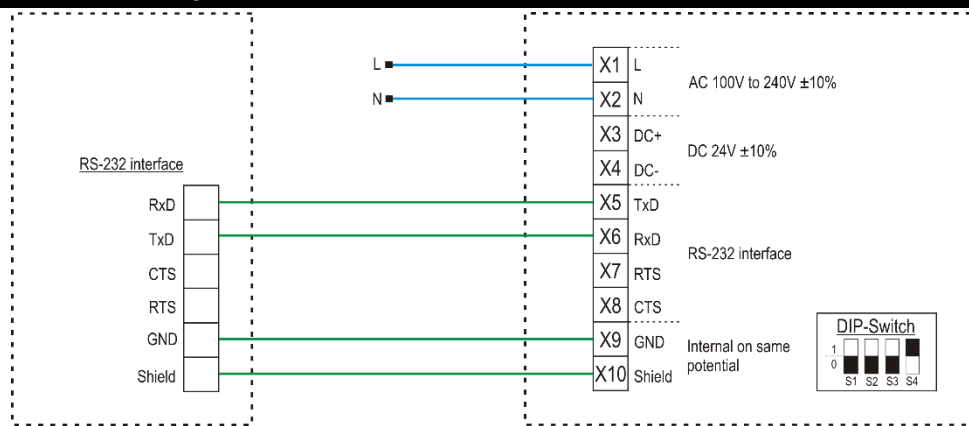

PC/Host with serial RS232- interface	Max. cable length is 15 m	UVM-Bluetooth (e.g. 1 st generation with DIP switch)
<p>Wiring:</p> <p>Blue wire → necessary (example connection to AC)</p> <p>Green line → necessary</p> <p>The signals RTS and CTS are not in use/no function internally. The terminals can only be used to connect the wires.</p> <p>For data lines (green and orange) we strongly recommend to use shielded (e.g. CAT5, similar or higher quality) cables.</p>		



The DIP switch is only populated in the 1st generation of the USM. From the 2nd generation onwards, the interface is set via programming barcodes.

- Windows 10, 8.1, 8, 7 --- 32/64 bit

BARTEC download page: <http://automation.bartec.de/indexE.htm>

6.1.3 Setting/programming

The programming barcodes have been taken from the original Zebra Product Reference Guide (PRG).



The functions of the BCS3608^{ex} and BCS3678^{ex} are based on the Zebra DS3608-HP/ER and DS3678-HP/ER.

The Guide is available to download from Zebra or from BARTEC:

Zebra support download page:



<https://www.zebra.com/us/en/support-downloads.html>

- Barcode Scanners
- Ultra Rugged Scanners – DS3608-HP/DS3678-HP and DS3608-ER/DS3678-ER

BARTEC download page:

<http://automation.bartec.de/indexE.htm>

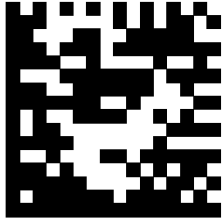
- Data capture

Function	Barcode
<p>Set factory defaults Scan the barcode for factory settings to remove all customized defaults and set the digital scanner to factory default settings (factory defaults can be found in the Zebra PRG, <i>Appendix A, Standard Default Parameters</i>).</p>	
<p>Default settings</p>	<p>Hand-held scanner is set as HID device.</p>
<p>Unpairing Delete all existing Bluetooth connections.</p>	
<p>Prepare the scanner to pair with the universal supply module. Scan in the “Bluetooth Serial Port Profile (Master)” barcode.</p>	



The **“Bluetooth Serial Port Profile (Master)”** barcode can be created at any time using the Zebra 123Scan utility.

Scan in the pairing barcode on the universal supply module. The barcode can be found on the cover.

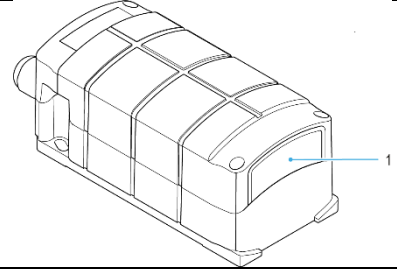

The barcode for pairing can be created at any time using the Zebra 123Scan utility. Use the MAC address of the Bluetooth module in the universal supply module for this.



Programming/setting via the Zebra 123 Scan Utility is not supported via the USM. A programming cable is required.



The hand-held scanner is paired to the universal supply module via Bluetooth. The universal supply module transmits serial data on the output side. You can find the set factory defaults below.

	<u>RS-232 host parameters</u>	<u>RS-232 host parameters</u>
Default settings of the Bluetooth module in the universal supply module	UVM 1. Generation:	UVM 2. Generation:
	Baud Rate: 115200 Baud	Baud Rate: 9600 Baud
	Parity: None	
	Stop bits: 1-Bit	
	Data bits: 8-Bit	
	Hardware handshaking: None	
	Software handshaking: None	





Further customized settings can be performed with the help of the Zebra Product Reference Guide or the Zebra 123Scan utility.

6.1.4 Note on base station when used only for charging

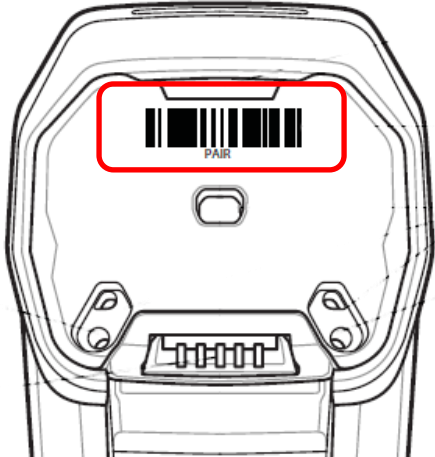

Observe the following notes when the base station is only used for charging to avoid possible problems with the Bluetooth connection.

“Pair on Contacts“ deactivate	
<p>If the base station is only used as a charging station, we recommend deactivating the "Pair on Contacts" function. Otherwise, the scanner will be automatically connected to the base station via the contacts. This means that the connection with another Bluetooth device such as the universal supply module must be done again.</p>	
<p>“Enable Pair On Contacts” The function is enabled in the factory settings and enables connection via the contacts on the base station.</p>	
<p>“Disable Pair on Contacts”</p>	
Cover the pairing barcode on the base station	
<p>If the base station is only used as a charging station, we recommend covering the pairing barcode on the base station so that a connection with the base station is not created by accidental scanning when inserting the scanner. This will result in the need to reconnect to another Bluetooth device such as the Universal Power Supply Module.</p>	
	

6.1.5 Testing communication/data transmission

The communication/data transmission on the host PC can be tested with the help of a terminal program or a software keyboard wedge.



A software wedge or other application must be installed on the host PC for data transmission when using a universal supply module.
 The software wedge or other application is used to convert the incoming data to a keyboard entry and to enter the data into the field currently active on the host PC.

Terminal program



The test with a terminal program described below was conducted with the H-Term application. Alternatively any other terminal program that supports serial communication may be used.

Testing communication/data transmission

Open terminal program

Select serial interface to which the BCS3608^{ex} is connected (COM1 in the example).
 Can be checked in the device manager.

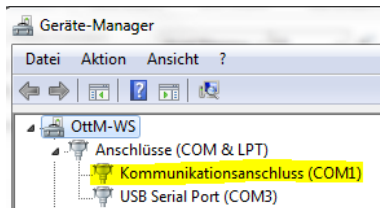

Perform settings in the terminal program and press 'Connect'.

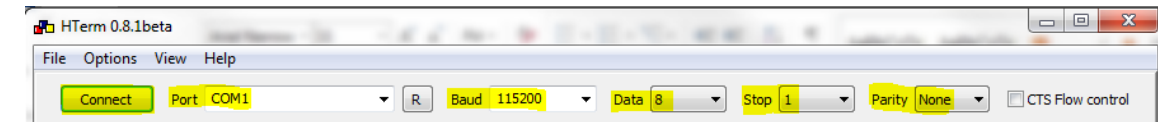

Read barcode with scanner and check in the terminal program that the data are displayed.

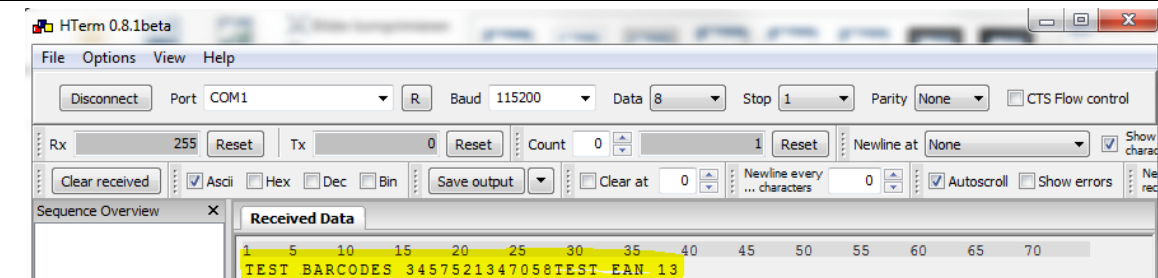

Data transmission is OK if the barcode data is displayed in the "Received Data" window.
 If not, check connection and programming.

7. Bluetooth BCS3678^{ex} hand-held scanner

7.1 Connection USB to PC via universal supply module

7.1.1 Components required

Functional system	
BCS3678^{ex}-IS	BCS3678^{ex}-NI
ATEX / IECEx Zone 1/21 NEC / CEC Class I, II, III Division 1	ATEX / IECEx Zone 2/22 NEC / CEC Class I, II, III Division 2
1 x	Bluetooth BCS3678 ^{ex} hand-held scanner
	Type: 17-A1S4-2HP1
	Type: B7-A2S4-2HP1 or B7-A2S4-2ER1
1 x	Universal supply module for hand-held scanners
	ATEX / IECEx Zone 1/21 Type: 17-A1Z0-0019
	ATEX / IECEx Zone 2/22 Type: B7-A2Z0-0043 NEC / CEC Class I, II, III Division 2 Type: B7-A2Z0-0043US
To be provided by the customer	
1 x	1 x USB connection cable to the host PC. Maximum cable length supported: 5 m Number of cores and recommended cable cross section: see BARTEC User Manual. http://automation.bartec.de/scanner.htm
	<u>NB:</u> – USB only functions as SPP (Serial Port Profile), HID is not supported. The universal supply module is detected by the host PC as a serial connection (virtual COM interface) – Please use standard, shielded data lines to prevent external disturbances. Recommendation: e.g. use CAT5, similar or higher quality cables
1 x	PC with USB 2.0 or USB 3.0 interface
1 x	Terminal program or software keyboard wedge for testing virtual COM communication and data transmission on the host PC.

7.1.2 Connection

Diagram

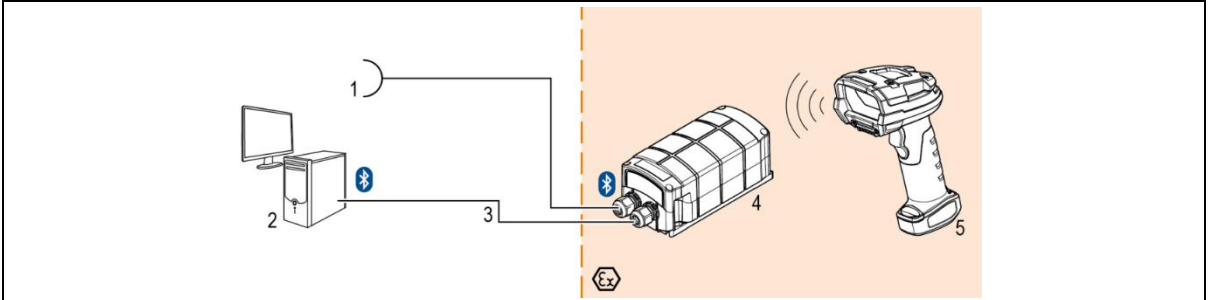

Pos.	Description
1	Power supply (100 to 240 V _{AC} ±10% / 50/60 Hz or 24 V _{DC} ±10% 0.4A) Note: NEC/CEC version only with 24V _{DC} .
2	Host PC
3	RS232 data cable from host PC to universal supply module (max. 15m)
4	Universal supply module for hand-held scanners
5	BCS 3678 ^{ex} hand-held scanner

Universal supply module

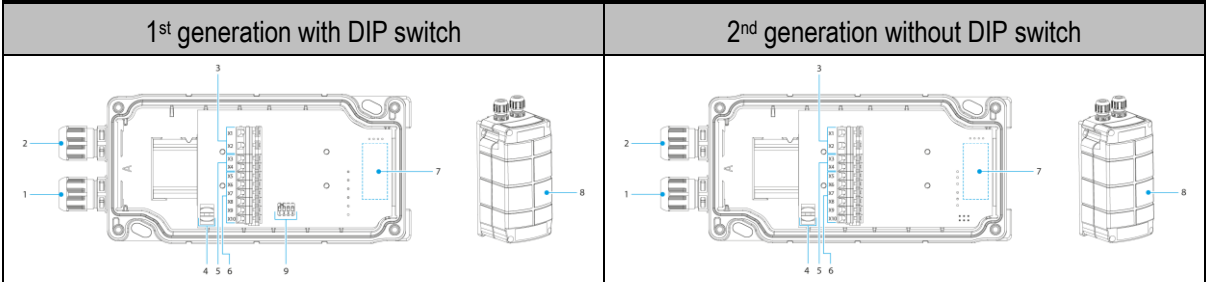

Pos.	Description	Function
1	Cable gland	Feed data cable to terminals
2	Cable gland	Feed power cord to terminals
3	Terminals X1 to X2	Connect 100 to 240 V _{AC} power supply
4	Shield clamp for ferrite core	The ferrite core is only needed when using the USB-SPP interface.
5	Terminals X3 to X4	Connect 24 V _{DC} power supply
6	Terminals X5 to X9	Connect USB-SPP data line
7	Position of the Bluetooth module	Only equipped for the Bluetooth version
8	Cover	Protect / seal terminal connection chamber
9	DIP switch	Select/set used interface: 1st generation: setup via DIP switches 2nd generation: setup via barcodes

Universal supply module - terminal assignment		
Terminal	Mains connection / USB interface	
X1	L (230V)	L = 100 V _{AC} to 240 V _{AC} ±10% / 50/60 Hz
X2	N (230V)	N = Neutral conductor
X3	+ (24V)	24 V _{DC+} ±10% / 0.4A
X4	- (24V)	24 V _{DC-} ±10% / 0.4A
X5	1	Data- (D-)
X6	2	Data+ (D+)
X7	3	-
X8	4	-
X9	GND	GND
X10	SHIELD	Placing the shield

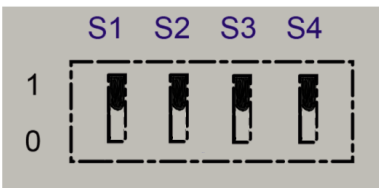
Universal supply module – 1 st generation with DIP switch					
Setting					
DIP switch	Interface	S1	S2	S3	S4
	USB-SPP	1	1	1	1



The interface is set using DIP switches S1, S2 and S3.
 DIP switch 4 is used to select whether the universal supply module is suitable for the wired or Bluetooth hand-held scanner.
 S4: 0 = wired / 1 = Bluetooth

Universal supply module – 2 nd generation without DIP switch	
Scan the programming code for the USB-SPP virtual serial interface.	 USB-SPP



The universal supply module (USM) is already preset on the hardware side to the Bluetooth scanner version.

Universal supply module – FTDI-FT232-R driver

Driver for the universal supply module (USM).

On connecting the USM, the drivers are automatically detected by the Windows operating system and installed if necessary.



If not detected automatically, the driver can be downloaded from the BARTEC download page or directly from the FTDI website (<https://www.ftdichip.com/>) and installed manually.

The driver is compatible with:

- Windows 10, 8.1, 8, 7 --- 32/64 bit

BARTEC download page: <http://automation.bartec.de/indexE.htm>

Wiring of universal supply module – USB-SPP interface

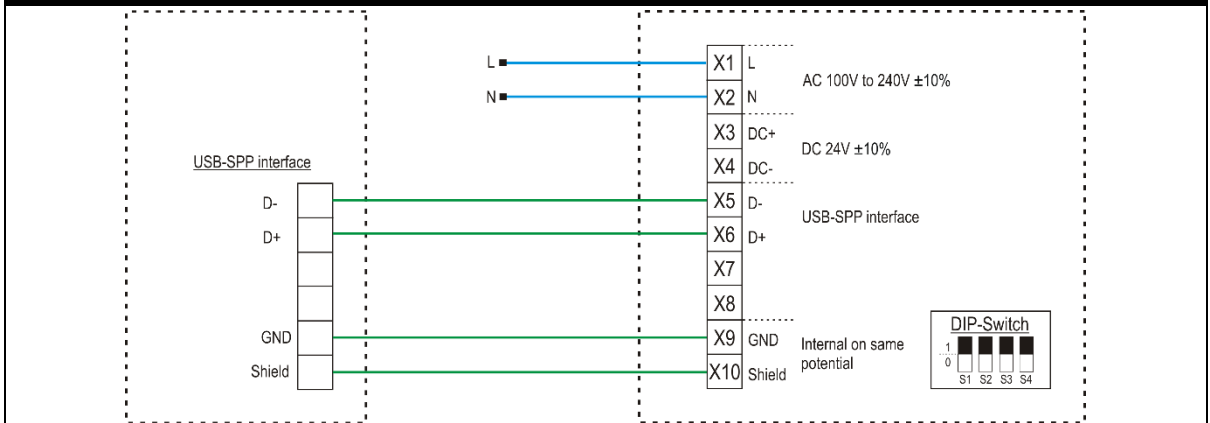

PC/Host with USB Interface USB-SPP = Serial Port Profile USB = virtual serial COM port	Max. cable length is 5 m	UVM-Bluetooth (e.g. 1st generation with DIP switch)
--	--------------------------	--

Wiring:
 Blue wire → necessary (example connection to AC)
 Green line → necessary
 For data lines (green) we strongly recommend to use shielded (e.g. CAT5, similar or higher quality) cables.



The DIP switch is only populated in the 1st generation of the USM. From the 2nd generation onwards, the interface is set via programming barcodes.

Ferrite core for data line (only when using the USB-SPP interface)

On delivery, a plastic bag with a ferrite core is included in each supply module.



The ferrite core is only required when using the USB-SPP interface.
It is used for shielding and to avoid external interference on the data line.

The ferrite core must be attached as follows.

- Strip the data line
- Slide the ferrite core over the data line
- Place data line with bare shield in the shield terminal (on the board)
- Place the data line on the terminal strip.

Ferrite core for shielding external interference signals

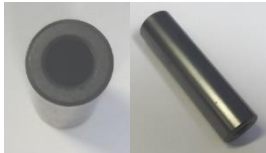

Installation in a supply module

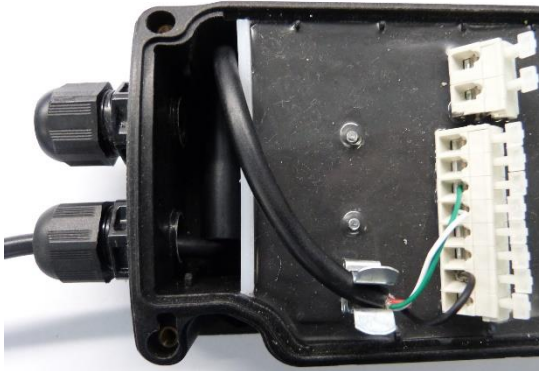

7.1.3 Setting/programming

The programming barcodes have been taken from the original Zebra Product Reference Guide (PRG).



The functions of the BCS3608^{ex} and BCS3678^{ex} are based on the Zebra DS3608-HP/ER and DS3678-HP/ER.

The Guide is available to download from Zebra or from BARTEC:

Zebra support download page:



<https://www.zebra.com/us/en/support-downloads.html>

- Barcode Scanners
- Ultra Rugged Scanners – DS3608-HP/DS3678-HP and DS3608-ER/DS3678-ER

BARTEC download page:

<http://automation.bartec.de/indexE.htm>

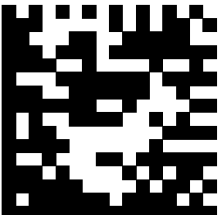
- Data capture

Function	Barcode
<p>Set factory defaults Scan the barcode for factory settings to remove all customized defaults and set the digital scanner to factory default settings (factory defaults can be found in the Zebra PRG, <i>Appendix A, Standard Default Parameters</i>).</p>	
<p>Default settings</p>	<p>Hand-held scanner is set as HID device.</p>
<p>Unpairing Delete all existing Bluetooth connections.</p>	
<p>Prepare the scanner to pair with the universal supply module. Scan in the “Bluetooth Serial Port Profile (Master)” barcode.</p>	

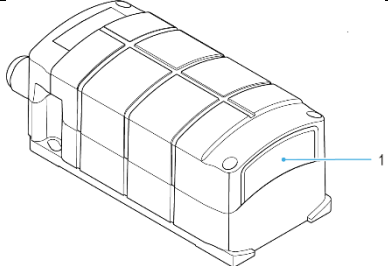

The **“Bluetooth Serial Port Profile (Master)”** barcode can be created at any time using the Zebra 123Scan utility.

<p>Scan in the pairing barcode on the universal supply module. The barcode can be found on the cover.</p>	
---	---

i The barcode for pairing can be created at any time using the Zebra 123Scan utility. Use the MAC address of the Bluetooth module in the universal supply module for this.

i Programming/setting via the Zebra 123 Scan Utility is not supported via the USM. A programming cable is required.

i The hand-held scanner is paired to the universal supply module via Bluetooth. The universal supply module transmits serial data on the output side. The connected USB interface is detected by the host PC as a virtual serial (COM) interface.



<p>Default settings of the Bluetooth module in the universal supply module</p>	<p><u>RS-232 host parameters</u></p>	<p><u>RS-232 host parameters</u></p>
	<p>UVM 1. Generation: Baud Rate: 115200 Baud</p>	<p>UVM 2. Generation: Baud Rate: 9600 Baud</p>
	<p>Parity: None Stop bits: 1-Bit Data bits: 8-Bit Hardware handshaking: None Software handshaking: None</p>	

i Further customized settings can be performed with the help of the Zebra Product Reference Guide or the Zebra 123Scan utility.

7.1.4 **Note on base station when used only for charging**

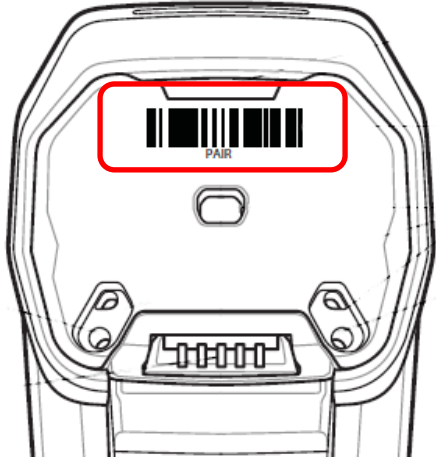

Observe the following notes when the base station is only used for charging to avoid possible problems with the Bluetooth connection.

“Pair on Contacts“ deactivate	
<p>If the base station is only used as a charging station, we recommend deactivating the "Pair on Contacts" function. Otherwise, the scanner will be automatically connected to the base station via the contacts. This means that the connection with another Bluetooth device such as the universal supply module must be done again.</p>	
<p>“Enable Pair On Contacts” The function is enabled in the factory settings and enables connection via the contacts on the base station.</p>	
<p>“Disable Pair on Contacts”</p>	
Cover the pairing barcode on the base station	
<p>If the base station is only used as a charging station, we recommend covering the pairing barcode on the base station so that a connection with the base station is not created by accidental scanning when inserting the scanner. This will result in the need to reconnect to another Bluetooth device such as the Universal Power Supply Module.</p>	
	

7.1.5 Testing communication/data transmission

The communication/data transmission on the host PC can be tested with the help of a terminal program or a software keyboard wedge.



A software wedge or other application must be installed on the host PC for data transmission when using a universal supply module.
 The software wedge or other application is used to convert the incoming data to a keyboard entry and to enter the data into the field currently active on the host PC.

Terminal program



The test with a terminal program described below was conducted with the H-Term application. Alternatively any other terminal program that supports serial communication may be used.

Testing communication/data transmission

Open terminal program

Select serial interface to which the BCS3608^{ex} is connected (COM6 in the example).
 Can be checked in the device manager.

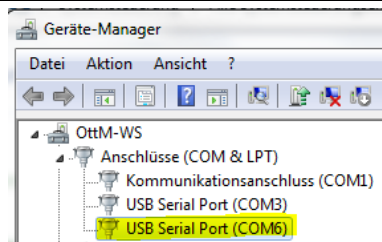

Perform settings in the terminal program and press 'Connect'.



Read barcode with scanner and check in the terminal program that the data are displayed.

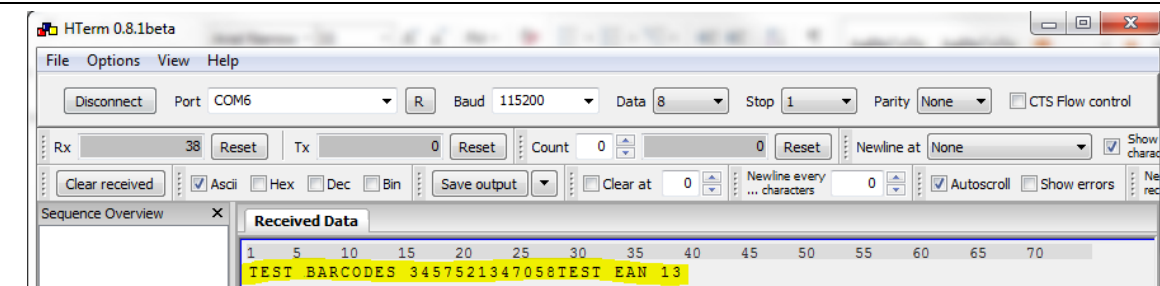

Data transmission is OK if the barcode data is displayed in the "Received Data" window.
 If not, check connection and programming.

8. Bluetooth BCS3678^{ex} hand-held scanner

8.1 Connection via cradle as HID device to host PC

8.1.1 Components required

Functional system			
BCS3678^{ex}-IS		BCS3678^{ex}-NI	
ATEX / IECEx Zone 1/21		ATEX / IECEx Zone 2/22	
NEC / CEC Class I, II, III Division 1		NEC / CEC Class I, II, III Division 2	
1 x	Bluetooth BCS3678 ^{ex} hand-held scanner		
	Type: 17-A1S4-2HP1		Type: B7-A2S4-2HP1 or B7-A2S4-2ER1
1 x	Cradle for hand-held scanner (data communication and charging the battery in the hand-held scanner)		
	17-A1Z0-0014		Type: G7-A0Z0-0010
1 x	Power supply unit with DC connection cable		
	G7-A0Z0-0019		G7-A0Z0-0019
1 x	AC mains lead		
	- US + Canada	G7-A0Z0-0024	- US + Canada
	- EU + APAC	G7-A0Z0-0026	- EU + APAC
	- TAIWAN	G7-A0Z0-0027	- TAIWAN
1 x	Connection cable - USB: 1.9 m (smooth) – connection between cradle and host PC		
	17-A1Z0-0020		G7-A0Z0-0018
To be provided by the customer			
1 x	PC with USB 2.0 or USB 3.0 interface		



The hand-held scanner is set as an HID device in factory defaults, and can be directly connected to the USB of the host PC.

8.1.2 Connection

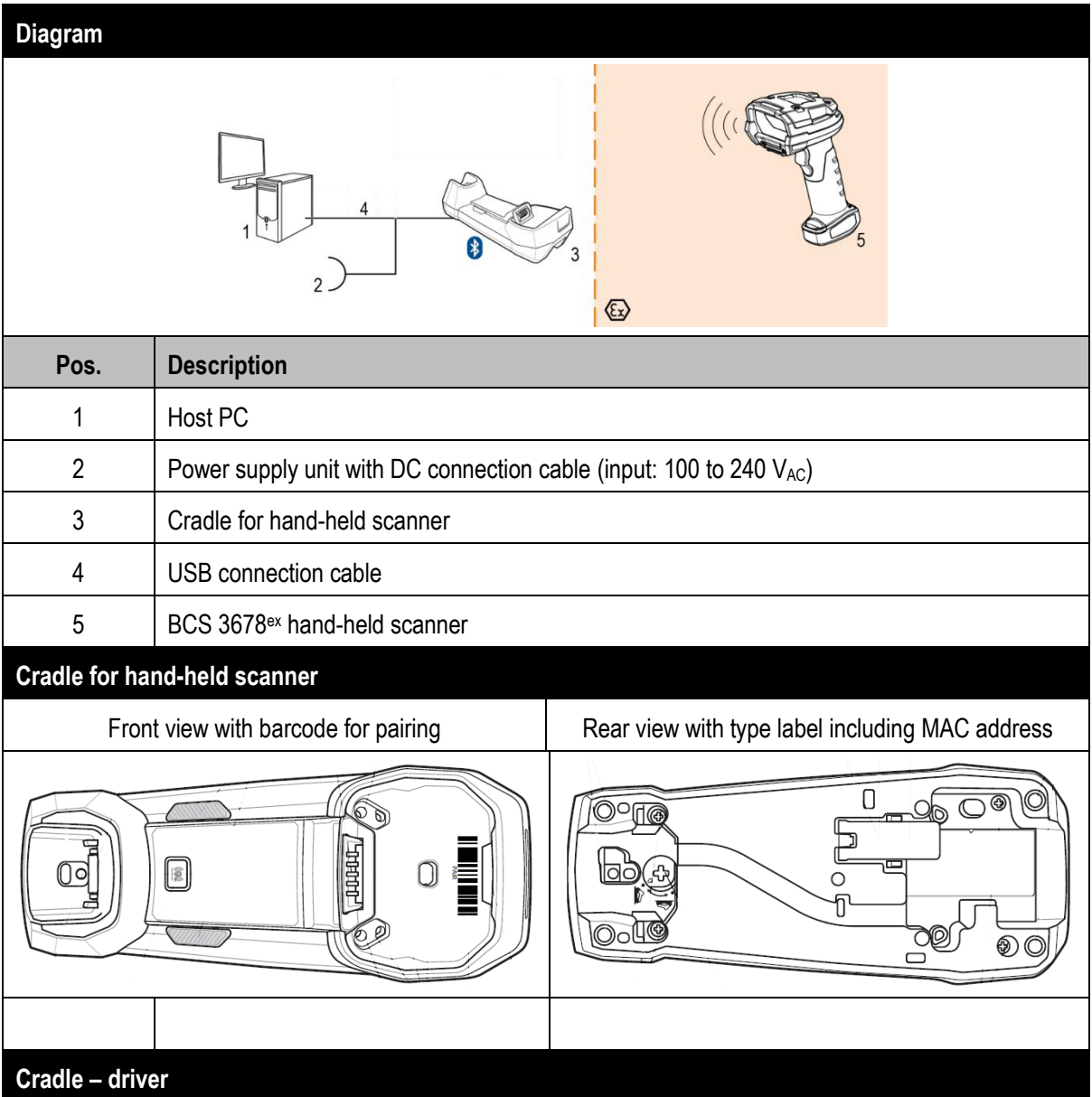

Driver for the cradle.

On connecting the cradle, the drivers are automatically detected by the Windows operating system and installed if necessary.

If not detected automatically, the driver can be downloaded from the Zebra website and installed manually.



Zebra support download page:

<https://www.zebra.com/us/en/support-downloads.html>

- Barcode Scanners

Ultra Rugged Scanners – DS3608-HP/DS3678-HP

8.1.3 Setting/programming

The programming barcodes have been taken from the original Zebra Product Reference Guide (PRG).



The functions of the BCS3608^{ex} and BCS3678^{ex} are based on the Zebra DS3608-HP/ER and DS3678-HP/ER.

The Guide is available to download from Zebra or from BARTEC:

Zebra support download page:

<https://www.zebra.com/us/en/support-downloads.html>

- Barcode Scanners
- Ultra Rugged Scanners – DS3608-HP/DS3678-HP and DS3608-ER/DS3678-ER

BARTEC download page:

<http://automation.bartec.de/indexE.htm>

- Data capture

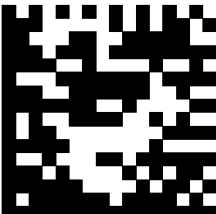
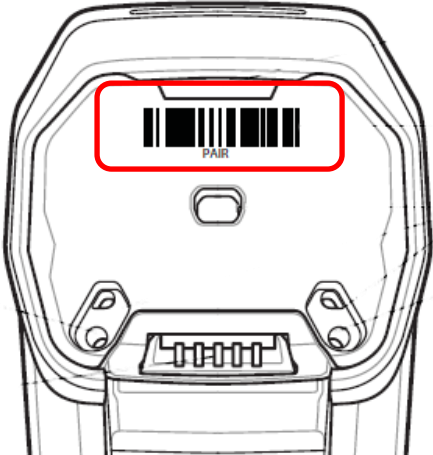
Function	Barcode
<p>Set factory defaults Scan the barcode for factory settings to remove all customized defaults and set the digital scanner to factory default settings (factory defaults can be found in the Zebra PRG, <i>Appendix A, Standard Default Parameters</i>).</p>	
<p>Default settings</p>	<p>Hand-held scanner is set as HID device.</p>
<p>Unpairing Delete all existing Bluetooth connections.</p>	
<p>Prepare the scanner to pair with the universal supply module. Scan in the pairing barcode on the cradle.</p>	



The barcode for pairing can be created at any time using the Zebra 123Scan utility. Use the MAC address of the base station for this.



The hand-held scanner is paired to the cradle via Bluetooth. The cradle transmits the data on the output side as USB HID. The cradle is detected by the host PC as USB device.



Further customized settings can be performed with the help of the Zebra Product Reference Guide or the Zebra 123Scan utility.

8.1.4 Testing communication/data transmission

The cradle is detected as USB device. The scanned data is transmitted as HID (Human Interface Device). The hand-held scanner functions in this mode as a keyboard entry.

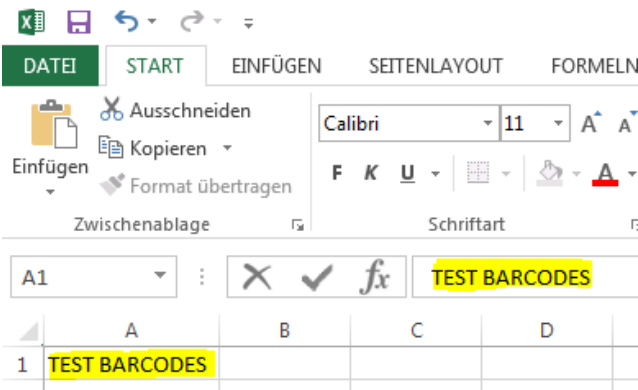
Testing communication/data transmission	
Open any program, such as Word, Notepad, Excel or other.	
Read the barcode with the scanner and check that data is displayed in the active field in the open program.	
	
Data transmission is OK if the barcode data is displayed. If not, check connection and programming	

9. Bluetooth BCS3678^{ex} hand-held scanner

9.1 Connection via cradle as serial device to host PC

9.1.1 Components required

Functional system			
BCS3678^{ex}-IS		BCS3678^{ex}-NI	
ATEX / IECEx Zone 1/21		ATEX / IECEx Zone 2/22	
NEC / CEC Class I, II, III Division 1		NEC / CEC Class I, II, III Division 2	
1 x	Bluetooth BCS3678 ^{ex} hand-held scanner		
	Type: 17-A1S4-2HP1		Type: B7-A2S4-2HP1 or B7-A2S4-2HP1
1 x	Cradle for hand-held scanner (data communication and charging the battery in the hand-held scanner)		
	17-A1Z0-0014		Type: G7-A0Z0-0010
1 x	Power supply unit with DC connection cable		
	G7-A0Z0-0019		G7-A0Z0-0019
1 x	AC mains lead		
	- US + Canada G7-A0Z0-0024		- US + Canada G7-A0Z0-0024
	- EU + APAC G7-A0Z0-0026		- EU + APAC G7-A0Z0-0026
	- TAIWAN G7-A0Z0-0027		- TAIWAN G7-A0Z0-0027
1 x	Connection cable – connection between cradle and host PC		
	- RS232: 1.9 m (smooth) 17-A1Z0-0026		- RS232: 2 m (smooth) G7-A0Z0-0014
	- RS232: 4.5 m (smooth) 17-A1Z0-0027		- RS232: 4.6 m (smooth) G7-A0Z0-0015
			- RS232: 2.8 m (spiral) G7-A0Z0-0016
To be provided by the customer			
1 x	PC with serial (COM) interface		
1 x	Terminal program or software keyboard wedge for testing serial (COM) communication and data transmission on the host PC		

9.1.2 Connection

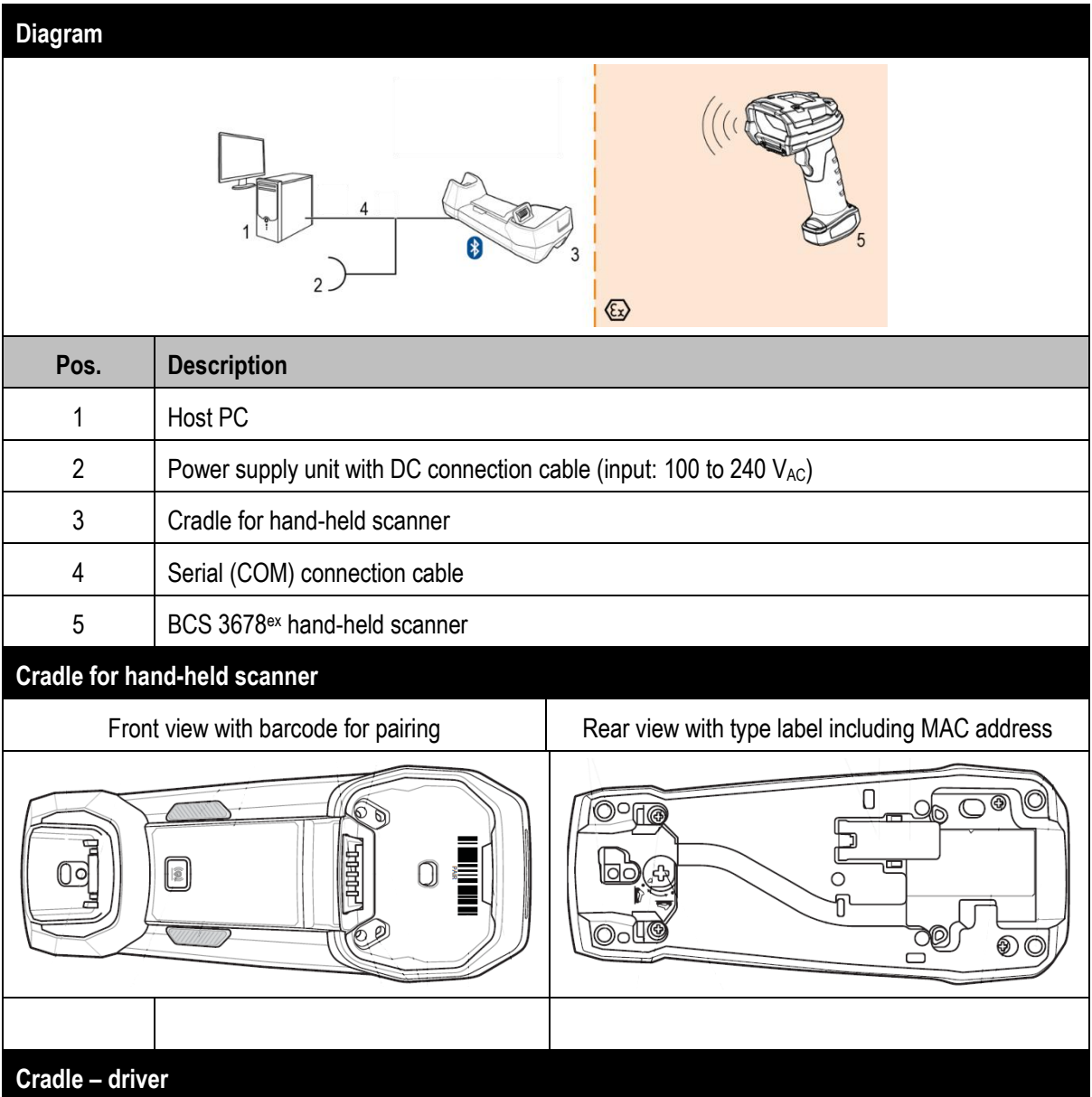

Driver for the cradle.

On connecting the cradle, the drivers are automatically detected by the Windows operating system and installed if necessary.

If not detected automatically, the driver can be downloaded from the Zebra website and installed manually.



Zebra support download page:

<https://www.zebra.com/us/en/support-downloads.html>

- Barcode Scanners

Ultra Rugged Scanners – DS3608-HP/DS3678-HP

9.1.3 Setting/programming

The programming barcodes have been taken from the original Zebra Product Reference Guide (PRG).



The functions of the BCS3608^{ex} and BCS3678^{ex} are based on the Zebra DS3608-HP/ER and DS3678-HP/ER.

The Guide is available to download from Zebra or from BARTEC:

Zebra support download page:



<https://www.zebra.com/us/en/support-downloads.html>

- Barcode Scanners
- Ultra Rugged Scanners – DS3608-HP/DS3678-HP and DS3608-ER/DS3678-ER

BARTEC download page:

<http://automation.bartec.de/indexE.htm>

- Data capture

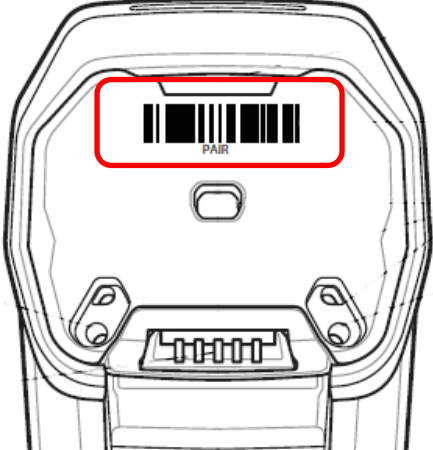
Function	Barcode
<p>Set factory defaults Scan the barcode for factory settings to remove all customized defaults and set the digital scanner to factory default settings (factory defaults can be found in the Zebra PRG, Appendix A, Standard Default Parameters).</p>	
<p>Unpairing Delete all existing Bluetooth connections.</p>	
<p>Default settings</p>	<p>Hand-held scanner is set as HID device.</p>
<p>Prepare the scanner to pair with the universal supply module. Scan in the pairing barcode on the cradle.</p>	



The barcode for pairing can be created at any time using the Zebra 123Scan utility. Use the MAC address of the base station for this.



The hand-held scanner is set as HID device in factory settings. The serial interface still needs to be activated with the help of a programming barcode.

<p>Scan in the “Standard RS-232” barcode to activate the serial RS232 interface.</p>	
<p>Default settings of the serial interface (COM)</p>	<p><u>RS-232 host parameters</u></p> <p>Baud rate: 9600 baud</p> <p>Parity: None</p> <p>Stop bits: 1-bit</p> <p>Data bits: 8-bit</p> <p>Hardware handshaking: None</p> <p>Software handshaking: None</p>



The hand-held scanner is paired to the cradle via Bluetooth. The cradle transmits serial data. The cradle is detected by the host PC as a serial device.



Further customized settings can be performed with the help of the Zebra Product Reference Guide or the Zebra 123Scan utility.

9.1.4 Testing communication/data transmission

The communication/data transmission on the host PC can be tested with the help of a terminal program or a software keyboard wedge.



A software wedge or other application must be installed on the host PC for data transmission when using a serial interface.

The software wedge or other application is used to convert the incoming data to a keyboard entry and to enter the data into the field currently active on the host PC.

Terminal program

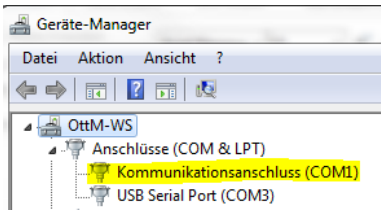
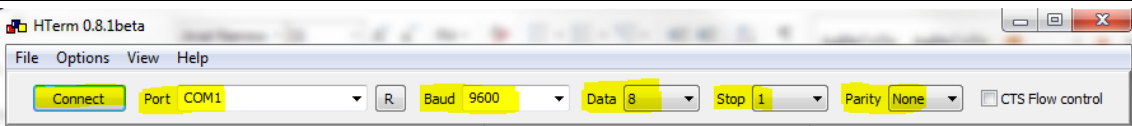
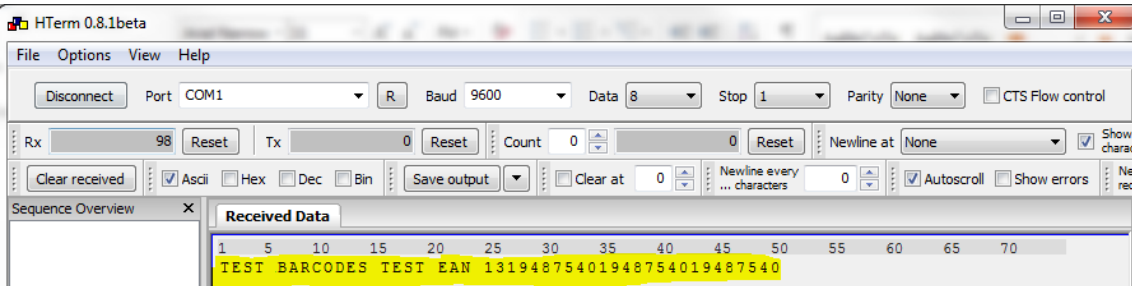

The test with a terminal program described below was conducted with the H-Term application. Alternatively any other terminal program that supports serial communication may be used.

Testing communication/data transmission
Terminal Programm öffnen
Select serial interface to which the BCS3608 ^{ex} is connected (COM1 in the example). Can be checked in the device manager.

Perform settings in the terminal program and press 'Connect'.

Read barcode with scanner and check in the terminal program that the data are displayed.

Data transmission is OK if the barcode data is displayed in the "Received Data" window. If not, check connection and programming.

10. Bluetooth BCS3678^{ex} hand-held scanner

10.1 Connection as HID device

10.1.1 Components required

Functional system			
BCS3678^{ex}-IS		BCS3678^{ex}-NI	
ATEX / IECEx Zone 1/21		ATEX / IECEx Zone 2/22	
NEC / CEC Class I, II, III Division 1		NEC / CEC Class I, II, III Division 2	
1 x	Bluetooth BCS3678 ^{ex} hand-held scanner		
	Type: 17-A1S4-2HP1		Type: B7-A2S4-2HP1 or B7-A2S4-2ER1
1 x	Only required for charging the battery: Cradle for hand-held scanner Alternatively a 4-slot charging station can be used.		
	17-A1Z0-0014		Type: G7-A0Z0-0010
1 x	Power supply unit with DC connection cable		
	G7-A0Z0-0019		G7-A0Z0-0019
1 x	AC mains lead		
	- US + Canada	G7-A0Z0-0024	- US + Canada
	- EU + APAC	G7-A0Z0-0026	- EU + APAC
	- TAIWAN	G7-A0Z0-0027	- TAIWAN
To be provided by the customer			
1 x	PC with Bluetooth module		



The hand-held scanner is equipped with a Bluetooth module. The hand-held scanner is set as HID device in factory defaults and can be directly connected to other equipment with a Bluetooth module.

10.1.2 Connection

Diagram

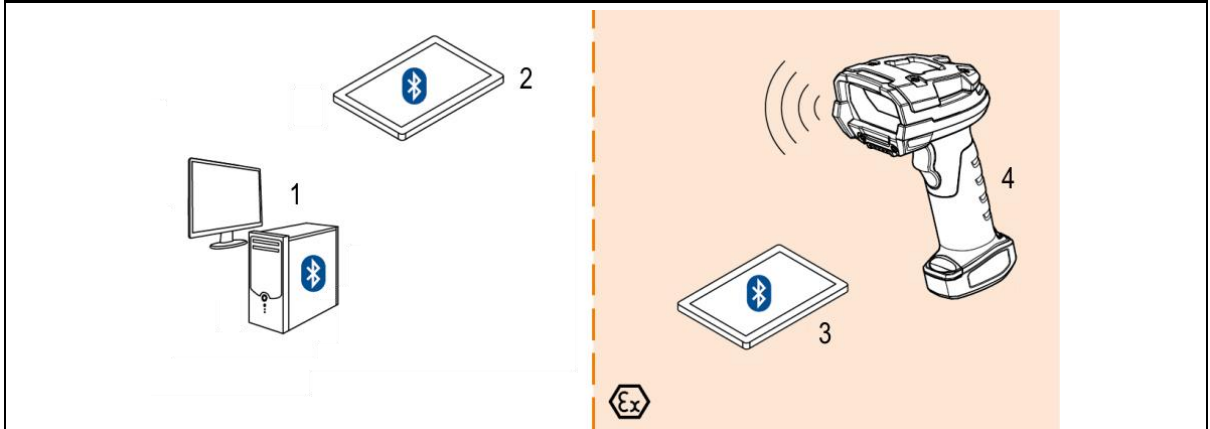

Pos.	Description
1	Host PC with Bluetooth
2	Mobile device with Bluetooth for non-hazardous areas (e.g. Agile tablet PC or other)
3	Mobile device with Bluetooth for potentially explosive atmospheres (e.g. Agile X or Agile X IS tablet PC, or other)
4	BCS 3678 ^{ex} hand-held scanner

10.1.3 Setting/programming

The programming barcodes have been taken from the original Zebra Product Reference Guide (PRG).



The functions of the BCS3608^{ex} and BCS3678^{ex} are based on the Zebra DS3608-HP/ER and DS3678-HP/ER.

The Guide is available to download from Zebra or from BARTEC:

Zebra support download page:





<https://www.zebra.com/us/en/support-downloads.html>

- Barcode Scanners
- Ultra Rugged Scanners – DS3608-HP/DS3678-HP and DS3608-ER/DS3678-ER

BARTEC download page:

<http://automation.bartec.de/indexE.htm>

- Data capture

Function	Barcode
<p>Set factory defaults Scan the barcode for factory settings to remove all customized defaults and set the digital scanner to factory default settings (factory defaults can be found in the Zebra PRG, <i>Appendix A, Standard Default Parameters</i>).</p>	
<p>Default settings</p>	<p>Hand-held scanner is set as HID device.</p>
<p>Unpairing Delete all existing Bluetooth connections.</p>	
<p>Prepare the hand-held scanner for pairing with other Bluetooth-enabled devices. Select from the two keyboard emulation options and scan one of the two barcodes:</p> <ul style="list-style-type: none"> • “HID Bluetooth Classic” • “HID BT LE (Discoverable)” <p>Enables the host PC to establish an HID (Human Interface Device) connection with the hand-held scanner via Bluetooth Classic or Low Energy. The hand-held scanner is recognizable on the host PC (slave mode). To establish a connection (initial setup only):</p> <ul style="list-style-type: none"> • Scan one of the barcodes • Find the DS36xx in the Bluetooth Manager on your host PC. • Select your hand-held scanner and establish the connection. 	<div style="text-align: center;">  <p>HID Bluetooth Classic</p>  <p>HID BT LE (Discoverable)</p> </div>

Classic Bluetooth vs. Low Energy Bluetooth



Bluetooth Low Energy (LE) has a better Wi-Fi coexistence, as advertising and connection is done outside of the Wi-Fi channels 1, 6, and 11 (2402, 2426, 2480 MHz). Due to its lower data rate, Bluetooth Low Energy is up to seven times slower than Classic Bluetooth (0.27 Mbps versus 0.7-2.1 Mbps). Data intensive activities such as firmware updates, can take significantly longer over Bluetooth Low Energy.



The hand-held scanner is directly connected via Bluetooth to the host PC with the Bluetooth module. Data transmitted from the hand-held scanner will be processed by the host PC as keyboard entry.





Further customized settings can be performed with the help of the Zebra Product Reference Guide or the Zebra 123Scan utility.

10.1.4 Note on base station when used only for charging



Observe the following notes when the base station is only used for charging to avoid possible problems with the Bluetooth connection.

“Pair on Contacts“ deactivate	
<p>If the base station is only used as a charging station, we recommend deactivating the "Pair on Contacts" function. Otherwise, the scanner will be automatically connected to the base station via the contacts. This means that the connection with another Bluetooth device such as the universal supply module must be done again.</p>	
<p>“Enable Pair On Contacts” The function is enabled in the factory settings and enables connection via the contacts on the base station.</p>	
<p>“Disable Pair on Contacts”</p>	
Cover the pairing barcode on the base station	
<p>If the base station is only used as a charging station, we recommend covering the pairing barcode on the base station so that a connection with the base station is not created by accidental scanning when inserting the scanner. This will result in the need to reconnect to another Bluetooth device such as the Universal Power Supply Module.</p>	

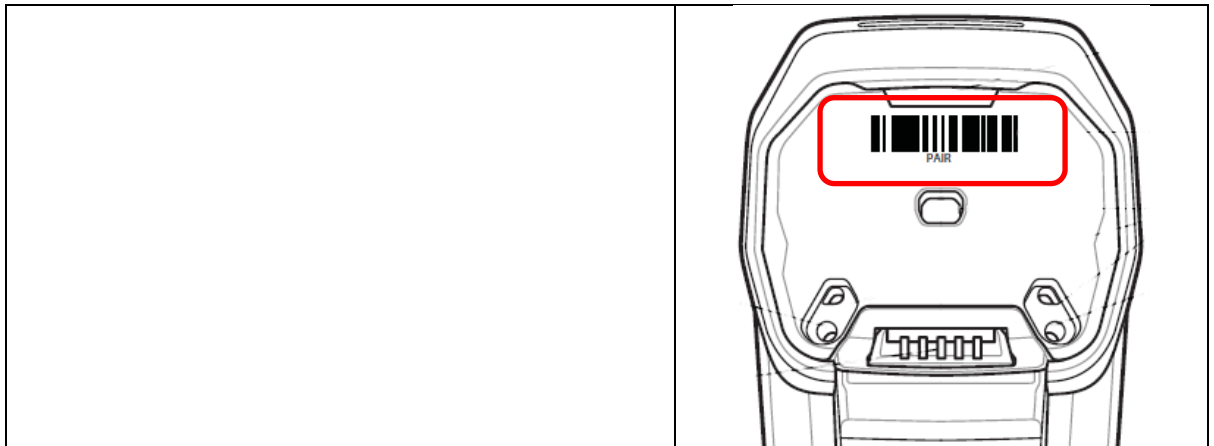

10.1.5 Testing communication/data transmission

The hand-held scanner is detected as HID device. The scanned data is transmitted as HID (Human Interface Device). The hand-held scanner functions in this mode as a keyboard entry.

Testing communication/data transmission

Open any program, such as Word, Notepad, Excel or other.

Read the barcode with the scanner and check that data are displayed in the active field in the open program.

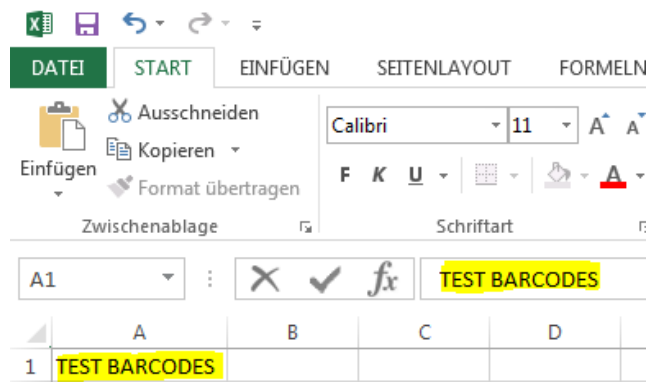

Data transmission is OK when the barcode data is displayed.

If not, check connection and programming.

11. Bluetooth BCS3678^{ex} hand-held scanner

11.1 Connection as serial port profile (SPP) device

11.1.1 Components required

Functional system			
BCS3678^{ex}-IS		BCS3678^{ex}-NI	
ATEX / IECEx Zone 1/21		ATEX / IECEx Zone 2/22	
NEC / CEC Class I, II, III Division 1		NEC / CEC Class I, II, III Division 2	
1 x	Bluetooth BCS3678 ^{ex} hand-held scanner		
	Type: 17-A1S4-2HP1		Type: B7-A2S4-2HP1 or B7-A2S4-2ER1
1 x	Only required for charging the battery: Cradle for hand-held scanner Alternatively a 4-slot charging station can be used.		
	17-A1Z0-0014		Type: G7-A0Z0-0010
1 x	Power supply unit with DC connection cable		
	G7-A0Z0-0019		G7-A0Z0-0019
1 x	AC mains lead		
	- US + Canada	G7-A0Z0-0024	- US + Canada
	- EU + APAC	G7-A0Z0-0026	- EU + APAC
	- TAIWAN	G7-A0Z0-0027	- TAIWAN
To be provided by the customer			
1 x	PC with Bluetooth module		



The hand-held scanner is equipped with a Bluetooth module. The hand-held scanner is set as HID device in factory defaults and can be directly connected to other equipment with a Bluetooth module.

11.1.2 Connection

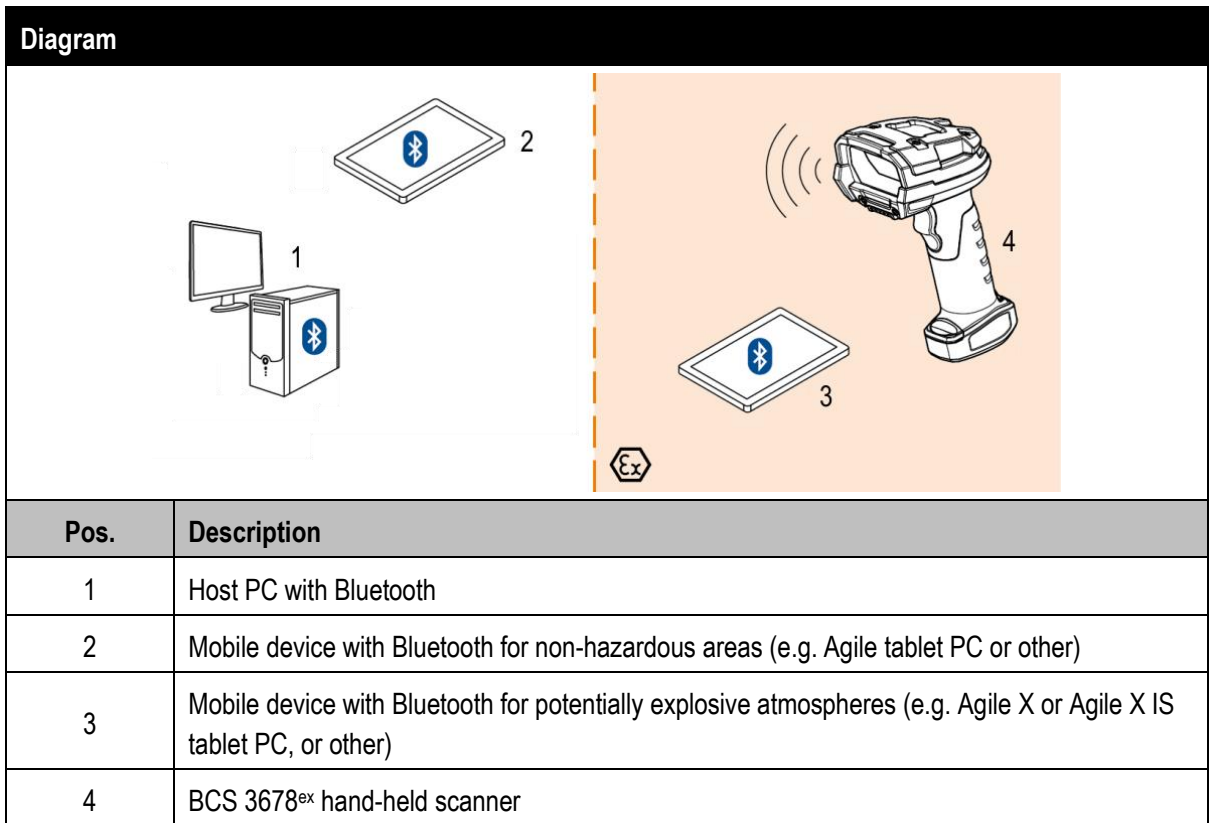

11.1.3 Setting/programming

The programming barcodes have been taken from the original Zebra Product Reference Guide (PRG).



The functions of the BCS3608^{ex} and BCS3678^{ex} are based on the Zebra DS3608-HP/ER and DS3678-HP/ER.

The Guide is available to download from Zebra or from BARTEC:

Zebra support download page:



<https://www.zebra.com/us/en/support-downloads.html>

- Barcode Scanners
- Ultra Rugged Scanners – DS3608-HP/DS3678-HP and DS3608-ER/DS3678-ER

BARTEC download page:

<http://automation.bartec.de/indexE.htm>

- Data capture

Function	Barcode
<p>Set factory defaults Scan the barcode for factory settings to remove all customized defaults and set the digital scanner to factory default settings (factory defaults can be found in the Zebra PRG, Appendix A, Standard Default Parameters).</p>	
<p>Default settings</p>	<p>Hand-held scanner is set as HID device.</p>
<p>Unpairing Delete all existing Bluetooth connections.</p>	
<p>SPP BT Classic (Discoverable) - Enables the host to establish a Serial Port Profile (SPP) connection with the scanner over Classic Bluetooth radio. The scanner is discoverable (Peripheral mode).</p> <p>To establish a connection (initial setup only):</p> <ul style="list-style-type: none"> • Scan the SPP BT Classic (Discoverable) barcode. • From the host, discover Bluetooth devices. <p>Select your scanner from the discovered device list.</p>	 <p>SPP BT Classic (Discoverable)</p>



The hand-held scanner is connected directly to the host PC with Bluetooth module via Bluetooth. The hand-held scanner is recognized by the host PC as a serial device. One or more COM ports are displayed in the Device Manager.

For data processing, software is required that receives serial data from the COM port and can process it further. E.g. Keyboard Wedge software.



Further customized settings can be performed with the help of the Zebra Product Reference Guide or the Zebra 123Scan utility.

11.1.4 Note on base station when used only for charging



Observe the following notes when the base station is only used for charging to avoid possible problems with the Bluetooth connection.

“Pair on Contacts“ deactivate	
If the base station is only used as a charging station, we recommend deactivating the "Pair on Contacts" function. Otherwise, the scanner will be automatically connected to the base station via the contacts. This means that the connection with another Bluetooth device such as the universal supply module must be done again.	
“Enable Pair On Contacts” The function is enabled in the factory settings and enables connection via the contacts on the base station.	
“Disable Pair on Contacts”	
Cover the pairing barcode on the base station	
If the base station is only used as a charging station, we recommend covering the pairing barcode on the base station so that a connection with the base station is not created by accidental scanning when inserting the scanner. This will result in the need to reconnect to another Bluetooth device such as the Universal Power Supply Module.	

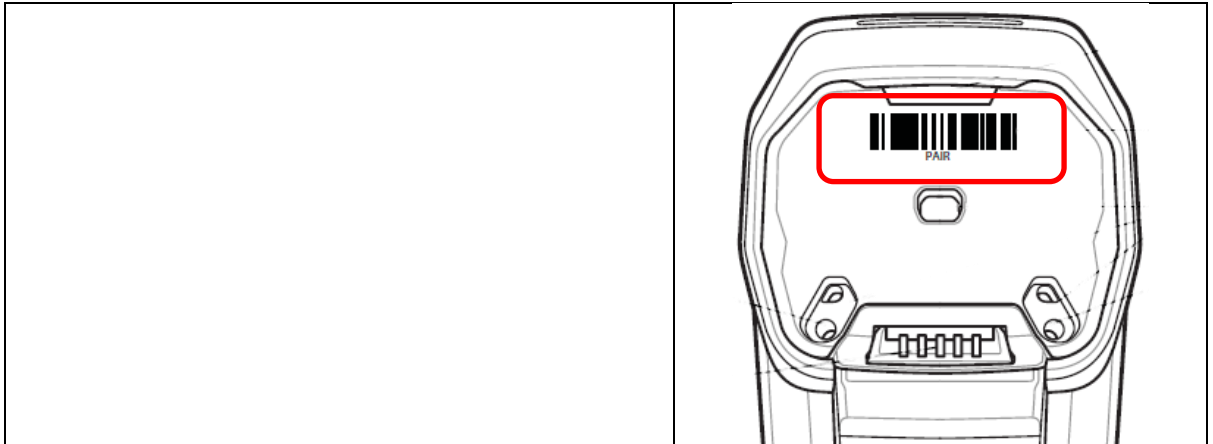

11.1.5 Testing communication/data transmission

The communication/data transmission can be tested with the help of a terminal program or a software keyboard wedge.



When using the Serial Port Profile (SPP), a software wedge or other application must be installed on the PC/host for data transmission.

The software wedge or other application is used to convert the incoming data as keyboard input and to enter the data in the currently active field on the PC/host.

Check which COM port has been added in the Device Manager.

Check which COM port works individually if several COM ports have been added.

In the example, COM 6 and COM 7 have been added.

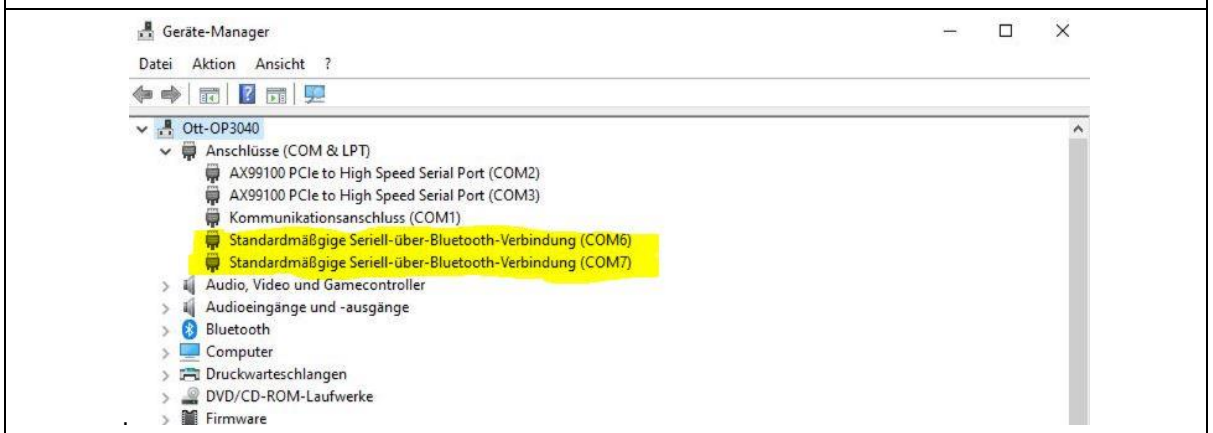

Terminal program



The test with a terminal program described below was conducted with the H-Term application. Alternatively any other terminal program that supports serial communication may be used.

Testing communication/data transmission

Open terminal program

Select serial interface to which the BCS3608^{ex} is connected (COM6 in the example).

Can be checked in the device manager.

Perform settings in the terminal program and press 'Connect'.

When the COM port is connected to the application, the scanner beeps to confirm that the connection is now ready for operation. The LED for the Bluetooth connection on the scanner turns green.



When the COM port is connected to the application, the scanner beeps to confirm that the connection is now ready for operation. The LED for the Bluetooth connection on the scanner turns green.

The scanner and the Bluetooth pairing are ready for operation.



Read barcode with scanner and check in the terminal program that the data are displayed.

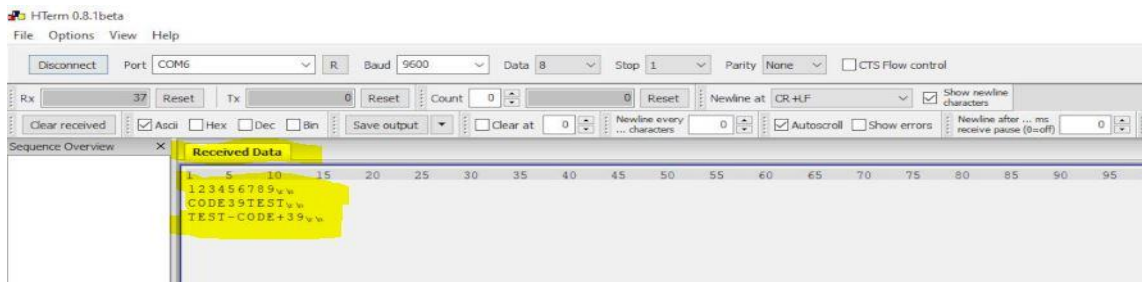

Data transmission is OK if the barcode data is displayed in the "Received Data" window.

If not, check connection and programming.

12. Supply Module Ex i with BCS3608^{ex} hand-held scanner

12.1 Connection RS232 via supply module Ex i – type: 17-A1Z0-0025 (e.g. on Ex-HMI)

12.1.1 Components required

Functional system	
BCS3608 ^{ex} -IS	
ATEX / IECEx Zone 1/21	
NEC / CEC Class I, II, III Division 1	
1 x	Wired BCS3608 ^{ex} hand-held scanner
	Type: 17-A1S4-1HP0
1 x	Supply module Ex i for hand-held scanner BCS3608 ^{ex}
	Only available for ATEX / IECEx Zone 1/21 Type: 17-A1Z0-0025
1 x	Connection cable for connection between universal supply module and scanner
	Type: 17-A1Z0-0015 or 17-A1Z0-0016 or 17-A1Z0-0017
To be provided by the customer	
1 x	1 x RS232 connection cable to the host PC. Maximum cable length supported: 15 m Number of cores and recommended cable cross section: see BARTEC User Manual NB: – The default setting for the hand-held scanner is as an HID device. The serial interface still needs to be activated with the help of a programming barcode. The supply module is then detected by the Ex-HMI as a series connection. – Please use standard, shielded data lines to prevent external disturbances. Recommendation: e.g. use CAT5, similar or higher quality cables
1 x	Ex-HMI with serial (COM) interface



The Ex relevant data of the power supply module Ex i must match the Ex relevant data of the Ex-HMI or any other Ex-device.

The Ex-relevant data of the BARTEC systems can be found in the corresponding Ex certificates, user manuals and data sheets. (www.bartec.com)

1 x	Terminal program or software keyboard wedge for testing virtual COM communication and data transmission on the host PC.
-----	---

12.1.2 Connection

Diagram

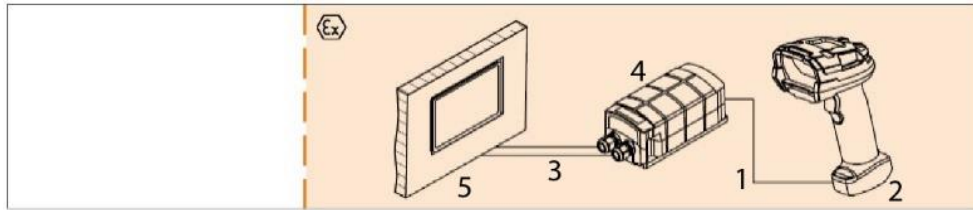

Pos.	Description
1	BCS 3608 ^{ex} connection cable
2	BCS 3608 ^{ex} hand-held scanner
3	RS232 data cable from Ex-HMI to supply module Ex i (max. 15m)
	Power supply (100 to 240 V _{AC} ±10% / 50/60 Hz or 24 V _{DC} ±10% 0.4A) Note: NEC/CEC version only with 24V _{DC} .
4	Supply module Ex i for hand-held scanners
5	Ex-HMI device Note: The Ex-HMI device can be replaced by any other Ex device with serial interface.
	It is important that the Ex-relevant data must be compatible with the BARTEC components. See BARTEC User Manual Chapter: "Ex-relevant values when connected to power supply module or other systems".

Supply module Ex i

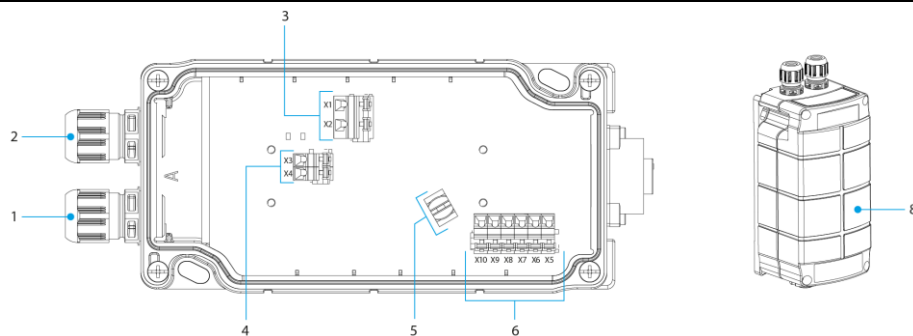

Pos.	Description	Function
1	Cable gland	Feed data cable to terminals
2	Cable gland	Feed power cord to terminals
3	Terminals X1 to X2	Connect 100 to 240 V _{AC} power supply
4	Terminals X3 to X4	Connect 24 V _{DC} power supply
5	Shield clamp for ferrite core	The ferrite core is only needed when using the USB-SPP interface.
6	Terminals X5 to X10	Connect data line
7	7-pole round plug N/A in the Bluetooth version	Plug for wired hand-held scanner
8	Cover	Protect / seal terminal connection chamber

Supply module Ex i - terminal assignment		
Terminal	Mains connection / RS232 interface	
X1	L = 100 V _{AC} to 240 V _{AC} ±10% / 50/60 Hz	
X2	N = Neutral conductor	
X3	24 V _{DC+} ±10% / 0.4A	
X4	24 V _{DC-} ±10% / 0.4A	
X5	RS232	TxD
X6		Shield
X7	USB-SPP	Ground (GND)
X8		Data + (D+)
X9		Data – (D-)
X10		5V (Host Powered / 5V of the RS232 or USB interface on host side)



The interface is only selected by correctly connecting the data line to the corresponding terminals.

Supply module Ex i –FTDI-FT232-R driver

Driver for the supply module Ex i.

On connecting the supply module, the drivers are automatically detected by the Windows operating system and installed if necessary.



If not detected automatically, the driver can be downloaded from the BARTEC download page or directly from the FTDI website (<https://www.ftdichip.com/>) and installed manually.

The driver is compatible with:

- Windows 10, 8.1, 8, 7 --- 32/64 bit

BARTEC download page: <http://automation.bartec.de/indexE.htm>

Wiring of supply module Ex i – RS232 interface

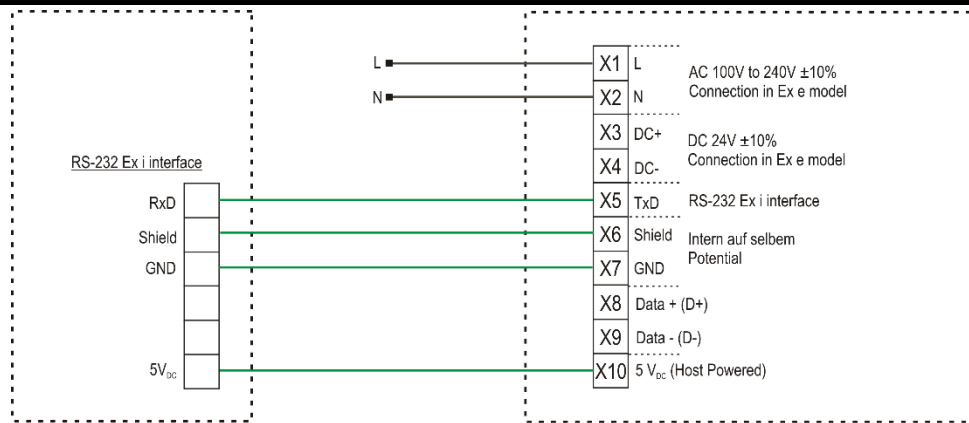

Ex-HMI/PC/Host with serial RS232-interface	Max. cable length is 15 m	Supply module Ex i - wired
--	---------------------------	----------------------------

Wiring:
 Black wire → necessary (example connection to AC)
 Green line → necessary

The signals RxD, RTS and CTS are not in use/no function internally. Only the TxD line is available to transfer data from the BCS36x8ex to the PC/host.

For data lines (green) we strongly recommend to use shielded (e.g. CAT5, similar or higher quality) cables. The Ex-HMI/PC/host must provide 5V_{DC} for the interface. The interface is "Host Powered".

Note:



The interfaces of the power supply module Ex i are passive.

The power supply module supplies only the hand scanner with power, but not the interface. The interface works in Ex i version with 5V_{DC}.

The interfaces themselves are supplied with power via the Ex-HMI or other Ex-device.

12.1.3 Setting/programming

The programming barcodes have been taken from the original Zebra Product Reference Guide (PRG).



The functions of the BCS3608^{ex} and BCS3678^{ex} are based on the Zebra DS3608-HP/ER and DS3678-HP/ER.

The Guide is available to download from Zebra or from BARTEC:

Zebra support download page:

<https://www.zebra.com/us/en/support-downloads.html>

- Barcode Scanners
- Ultra Rugged Scanners – DS3608-HP/DS3678-HP and DS3608-ER/DS3678-ER

BARTEC download page:

<http://automation.bartec.de/indexE.htm>

- Data capture

Function	Barcode
<p>Set factory defaults Scan the barcode for factory settings to remove all customized defaults and set the digital scanner to factory default settings (factory defaults can be found in the Zebra PRG, <i>Appendix A, Standard Default Parameters</i>).</p>	
<p>Default settings</p>	<p>Hand-held scanner is set as HID device.</p>
<p>Default settings of the RS232 interface (COM)</p>	<p><u>RS-232 host parameters</u></p> <p>Baud rate: 9600 baud Parity: None Stop bits: 1-bit Data bits: 8-bit Hardware handshaking: None Software handshaking: None</p>



The hand-held scanner is set as HID device as default. The serial interface still needs to be activated using a programming barcode.

<p>Scan in the “Standard RS-232” barcode to activate the serial RS232 interface.</p>	
---	---



Further customized settings can be performed with the help of the Zebra Product Reference Guide or the Zebra 123Scan utility.



Programming/setting via the Zebra 123 Scan Utility is not supported via the supply module Ex i.
A programming cable is required.

12.1.4 Testing communication/data transmission

The communication/data transmission on the Ex-HMI can be tested with the help of a terminal program or a software keyboard wedge.



A software wedge or other application must be installed on the Ex-HMI for data transmission when using a supply module Ex i.
The software wedge or other application is used to convert the incoming data to a keyboard entry and to enter the data into the field currently active on the host PC.

Terminal program

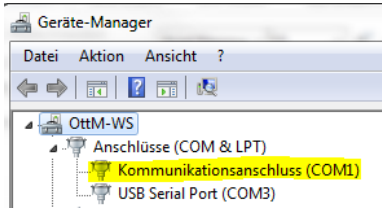
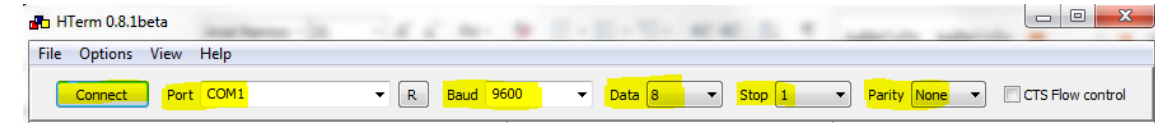

The test with a terminal program described below was conducted with the H-Term application. Alternatively any other terminal program that supports serial communication may be used.

Testing communication/data transmission
Open terminal program
Select serial interface to which the BCS3608 ^{ex} is connected (COM1 in the example). Can be checked in the device manager.

Perform settings in the terminal program and press 'Connect'.

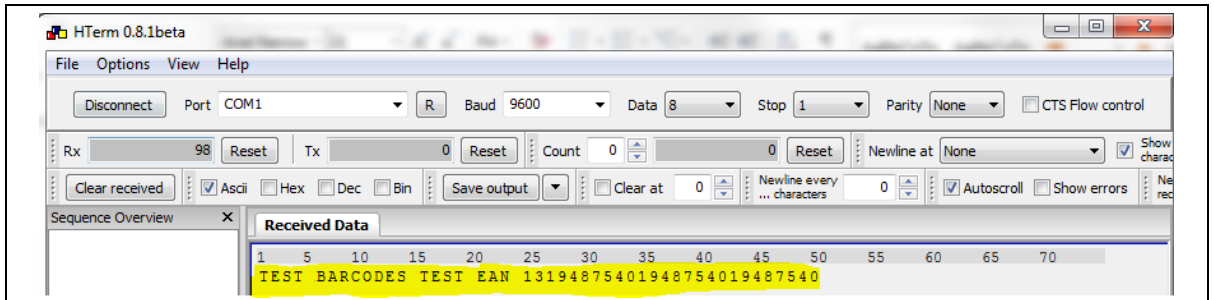
Read barcode with scanner and check in the terminal program that the data are displayed.

BCS36x8^{ex} Series Connection example
Type 17-A1S4-*HP* and B7-A2S4-****



Data transmission is OK if the barcode data is displayed in the "Received Data" window.
If not, check connection and programming.

13. Supply module Ex i with BCS3608^{ex} hand-held scanner

13.1 Connection USB via supply module Ex i - type: 17-A1Z0-0025 (e.g. on Ex-HMI)

13.1.1 Components required

Functional system	
BCS3608 ^{ex} -IS	
ATEX / IECEx Zone 1/21	
NEC / CEC Class I, II, III Division 1	
1 x	Wired BCS3608 ^{ex} hand-held scanner
	Type: 17-A1S4-1HP0
1 x	Supply module Ex i for hand-held scanners BCS3608 ^{ex}
	Only available for ATEX / IECEx Zone 1/21 Type: 17-A1Z0-0025
1 x	Connection cable for connection between universal supply module and scanner
	Type: 17-A1Z0-0015 or 17-A1Z0-0016 or 17-A1Z0-0017
To be provided by the customer	
1 x	1 x USB connection cable to the host PC Maximum cable length supported: 5 m Number of cores and recommended cable cross section: see BARTEC User Manual <u>NB:</u> – USB only functions as SPP (Serial Port Profile), HID is not supported. The universal supply module is detected by the host PC as a serial connection (virtual COM interface) – Please use standard, shielded data lines to prevent external disturbances. Recommendation: e.g. use CAT5, similar or higher quality cables
1 x	Ex-HMI with USB 2.0 or USB 3.0 interface



The Ex relevant data of the power supply module Ex i must match the Ex-relevant data of the Ex-HMI or any other Ex device.

The Ex-relevant data of the BARTEC systems can be found in the corresponding Ex certificates, user manuals and data sheets. (www.bartec.com)

1 x	Terminal program or software keyboard wedge for testing virtual COM communication and data transmission on the host PC.
-----	---

13.1.2 Connection

Diagram

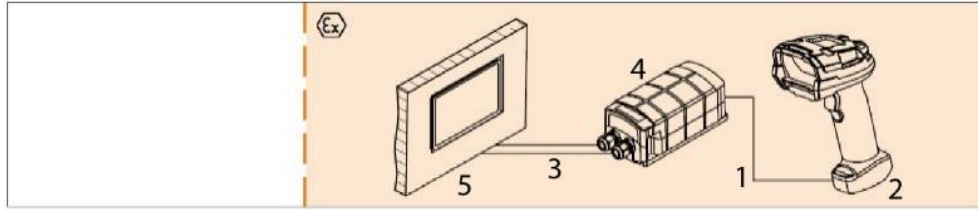

Pos.	Description
1	BCS 3608 ^{ex} connection cable
2	BCS 3608 ^{ex} hand-held scanner
3	USB data cable from Ex-HMI to supply module Ex i (max. 5m)
	Power supply (100 to 240 V _{AC} ±10% / 50/60 Hz or 24 V _{DC} ±10% 0.4A) Note: NEC/CEC version only with 24V _{DC} .
4	Supply module Ex i for hand-held scanners
5	Ex-HMI device Note: The Ex-HMI device can be replaced by any other Ex device with serial interface.
	It is important that the Ex-relevant data must be compatible with the BARTEC components. See BARTEC User Manual Chapter: "Ex-relevant values when connected to power supply module or other systems".

Supply module Ex i

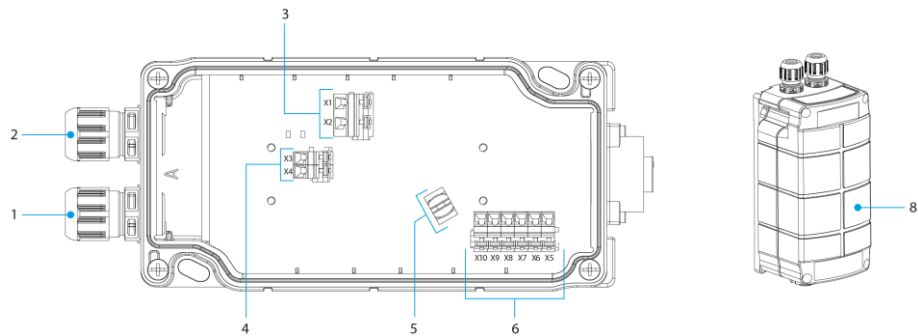

Pos.	Description	Function
1	Cable gland	Feed data cable to terminals
2	Cable gland	Feed power cord to terminals
3	Terminals X1 to X2	Connect 100 to 240 V _{AC} power supply
4	Terminals X3 to X4	Connect 24 V _{DC} power supply
5	Shield clamp for ferrite core	The ferrite core is only needed when using the USB-SPP interface.
6	Terminals X5 to X10	Connect data line
7	7-pole round plug N/A in the Bluetooth version	Plug for wired hand-held scanner
8	Cover	Protect / seal terminal connection chamber

Supply module Ex i - terminal assignment		
Terminal	Mains connection / USB interface	
X1	L = 100 V _{AC} to 240 V _{AC} ±10% / 50/60 Hz	
X2	N = Neutral conductor	
X3	24 V _{DC+} ±10% / 0.4A	
X4	24 V _{DC-} ±10% / 0.4A	
X5	RS232	TxD
X6		Shield
X7	USB-SPP	Ground (GND)
X8		Data + (D+)
X9		Data - (D-)
X10		5V (Host Powered / 5V of the RS232 or USB interface on host side)



The interface is only selected by correctly connecting the data line to the corresponding terminals.

Supply module Ex i –FTDI-FT232-R driver

Driver for the supply module Ex i.

On connecting the supply module, the drivers are automatically detected by the Windows operating system and installed if necessary.



If not detected automatically, the driver can be downloaded from the BARTEC download page or directly from the FTDI website (<https://www.ftdichip.com/>) and installed manually.

The driver is compatible with:

- Windows 10, 8.1, 8, 7 --- 32/64 bit

BARTEC download page: <http://automation.bartec.de/indexE.htm>

Wiring of supply module Ex i – USB-SPP interface

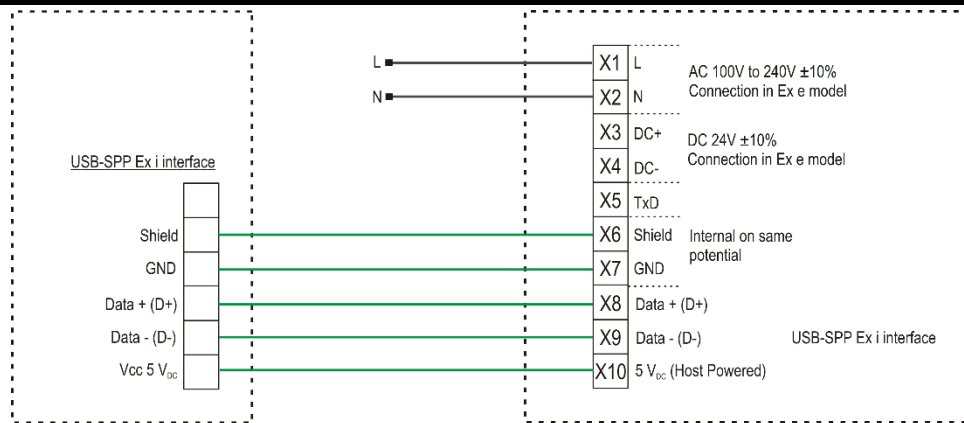

Ex-HMI/PC/Host with USB Interface USB-SPP = Serial Port Profile USB = virtual serial COM port	Max. cable length is 5 m	Supply module Ex i - wired
---	--------------------------	----------------------------

Wiring:
 Black wire → necessary (example connection to AC)
 Green line → necessary
 For data lines (green) we strongly recommend to use shielded (e.g. CAT5, similar or higher quality) cables.
 The Ex-HMI/PC/host must provide 5V_{DC} for the interface. The interface is "Host Powered".

Note:



The interfaces of the power supply module Ex i are passive.

The power supply module supplies only the hand scanner with power, but not the interface.

The interfaces themselves are supplied with power via the Ex-HMI or other Ex-device.

Ferrite core for data line (only when using the USB-SPP interface)

On delivery, a plastic bag with a ferrite core is included in each supply module.



The ferrite core is only required when using the USB-SPP interface.
It is used for shielding and to avoid external interference on the data line.

The ferrite core must be attached as follows.

- Strip the data line
- Slide the ferrite core over the data line
- Place data line with bare shield in the shield terminal (on the board)
- Place the data line on the terminal strip.

Ferrite core for shielding external interference signals

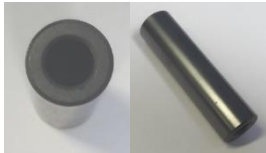

Installation in a supply module

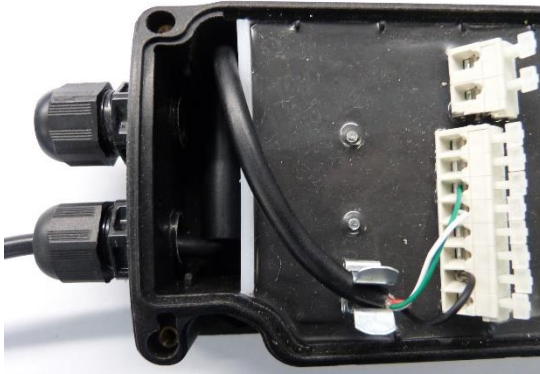

13.1.3 Setting/programming

The programming barcodes have been taken from the original Zebra Product Reference Guide (PRG).



The functions of the BCS3608^{ex} and BCS3678^{ex} are based on the Zebra DS3608-HP/ER and DS3678-HP/ER.

The Guide is available to download from Zebra or from BARTEC:

Zebra support download page:

<https://www.zebra.com/us/en/support-downloads.html>

- Barcode Scanners
- Ultra Rugged Scanners – DS3608-HP/DS3678-HP and DS3608-ER/DS3678-ER

BARTEC download page:

<http://automation.bartec.de/indexE>

- Data capture

Function	Barcode
<p>Set factory defaults Scan the barcode for factory settings to remove all customized defaults and set the digital scanner to factory default settings (factory defaults can be found in the Zebra PRG, Appendix A, Standard Default Parameters).</p>	
<p>Default settings</p>	<p>Hand-held scanner is set as HID device.</p>
<p>Default settings of the USB interface (virtual COM)</p>	<p><u>RS-232 host parameters</u></p> <p>Baud rate: 9600 baud Parity: None Stop bits: 1-bit Data bits: 8-bit Hardware handshaking: None Software handshaking: None</p>



USB functions only as SPP (Serial Port Profile), HID is not supported.
 The supply module Ex i is detected by the host PC as a serial connection (virtual COM interface)



Further customized settings can be performed with the help of the Zebra Product Reference Guide or the Zebra 123Scan utility.



Programming/setting via the Zebra 123 Scan Utility is not supported via the USM.
 A programming cable is required.

13.1.4 Testing communication/data transmission

The communication/data transmission on the Ex-HMI can be tested with the help of a terminal program or a software keyboard wedge.



A software wedge or other application must be installed on the Ex-HMI for data transmission when using a supply module Ex i.

The software wedge or other application is used to convert the incoming data to a keyboard entry and to enter the data into the field currently active on the host PC.

Terminal program

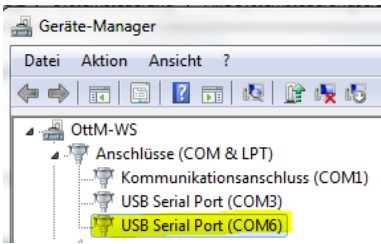
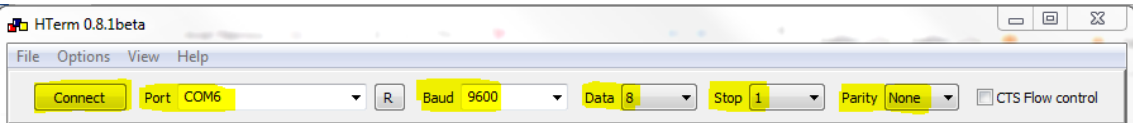
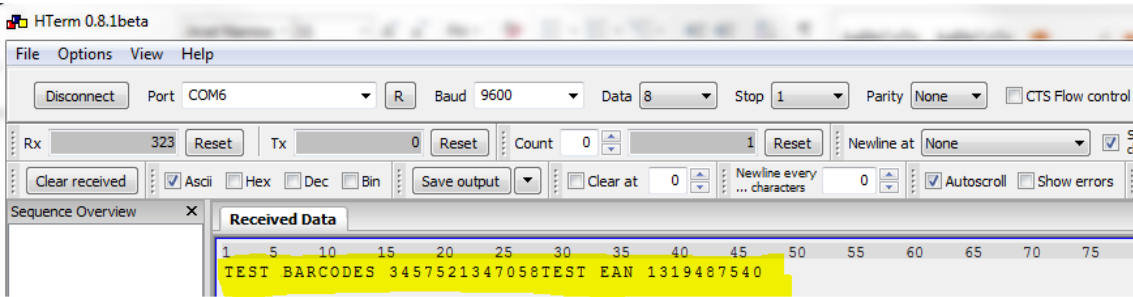

The test with a terminal program described below was conducted with the H-Term application. Alternatively any other terminal program that supports serial communication may be used.

Testing communication/data transmission
Open terminal program
Select serial interface to which the BCS3608 ^{ex} is connected (COM6 in the example). Can be checked in the device manager.

Perform settings in the terminal program and press 'Connect'.

Read barcode with scanner and check in the terminal program that the data are displayed.

Data transmission is OK if the barcode data is displayed in the "Received Data" window. If not, check connection and programming.

14. Supply module Ex i BT with BCS3678^{ex} hand-held scanner

14.1 Connection RS232 via supply module Ex i BT – type: 17-A1Z0-0028 (e.g. on Ex-HMI)

14.1.1 Components required

Functional system	
BCS3678^{ex}-IS ATEX / IECEx Zone 1/21 NEC / CEC Class I, II, III Division 1	
1 x	Bluetooth BCS3678 ^{ex} hand-held scanner
	Type: 17-A1S4-2HP1
1 x	Supply module Ex i for hand-held scanner
	ATEX / IECEx Zone 1/21 Type: 17-A1Z0-0028
To be provided by the customer	
1 x	1 x RS232 connection cable to the host PC Maximum cable length supported: 15m Number of cores and recommended cable cross section: see BARTEC User Manual <u>NB:</u> – The default setting for the hand-held scanner is as HID device. The serial interface still needs to be activated with the help of a programming barcode. The universal supply module is then detected by the host PC as a series connection. – Please use standard, shielded data lines to prevent external disturbances. Recommendation: e.g. use CAT5, similar or higher quality cables
1 x	Ex-HMI with serial (COM) interface



The Ex relevant data of the power supply module Ex i BT must match the Ex relevant data of the Ex HMI or any other Ex device.

The Ex-relevant data of the BARTEC systems can be found in the corresponding Ex certificates, user manuals and data sheets. (www.bartec.com)

1 x	Terminal program or software keyboard wedge for testing virtual COM communication and data transmission on the host PC.
-----	---

14.1.2 Connection

Diagram

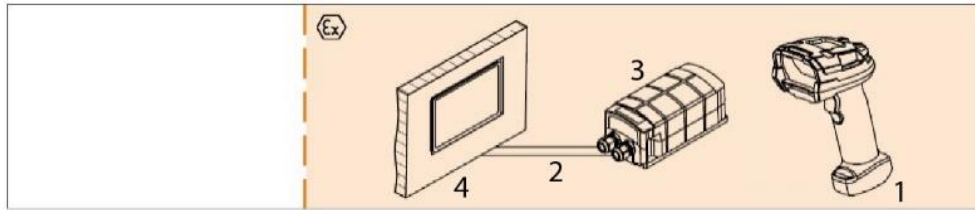

Pos.	Description
1	BCS 3678 ^{ex} hand-held scanner
2	RS232 data cable from Ex-HMI device to the supply module Ex i BT (max. 15m)
	Power supply (100 to 240 V _{AC} ±10% / 50/60 Hz or 24 V _{DC} ±10% 0.4A) Note: NEC/CEC version only with 24V _{DC} .
3	Supply module Ex i BT for hand-held scanner
4	Ex-HMI device Note: The Ex-HMI device can be replaced by any other Ex device with serial interface. It is important that the Ex-relevant data must be compatible with the BARTEC components. See BARTEC User Manual Chapter: "Ex-relevant values when connected to power supply module or other systems".

Universal supply module

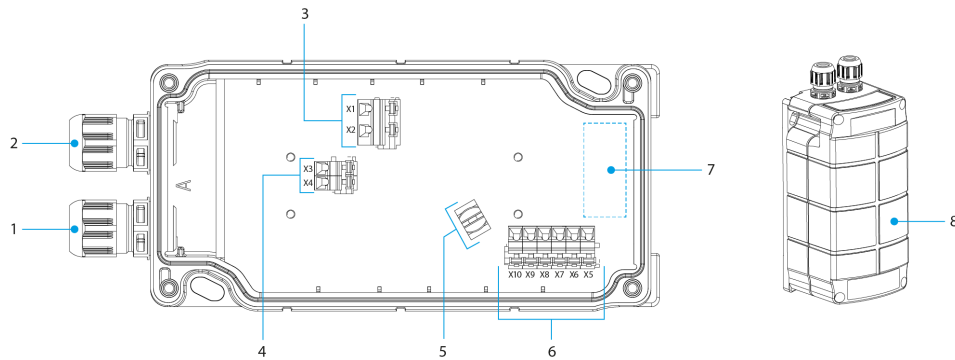

Pos.	Description	Function
1	Cable gland	Feed data cable to terminals
2	Cable gland	Feed power cord to terminals
3	Terminals X1 to X2	Connect 100 to 240 V _{AC} power supply
4	Terminals X3 to X4	Connect 24 V _{DC} power supply
5	Shield clamp for ferrite core	The ferrite core is only needed when using the USB-SPP interface.
6	Terminals X5 to X10	Connect data line
7	7-pole round plug N/A in the Bluetooth version	Plug for wired hand-held scanner
8	Cover	Protect / seal terminal connection chamber

Universal supply module - terminal assignment			
Terminal	Mains connection / RS232 interface		
X1	L = 100 V _{AC} to 240 V _{AC} ±10% / 50/60 Hz		
X2	N = Neutral conductor		
X3	24 V _{DC+} ±10% / 0.4A		
X4	24 V _{DC-} ±10% / 0.4A		
X5	RS232	USB-SPP	TxD
X6			Shield
X7			Ground (GND)
X8			Data + (D+)
X9			Data – (D-)
X10			5V (Host Powered / 5V of the USB interface on host side)



The interface is only selected by correctly connecting the data line to the corresponding terminals.

Supply module Ex i BT –FTDI-FT232-R driver

Driver for the supply module Ex i BT.

On connecting the USM, the drivers are automatically detected by the Windows operating system and installed if necessary.



If not detected automatically, the driver can be downloaded from the BARTEC download page or directly from the FTDI website (<https://www.ftdichip.com/>) and installed manually.

The driver is compatible with:

- Windows 10, 8.1, 8, 7 --- 32/64 bit

BARTEC download page: <http://automation.bartec.de/indexE.htm>

Wiring of supply module Ex i BT – RS232 interface

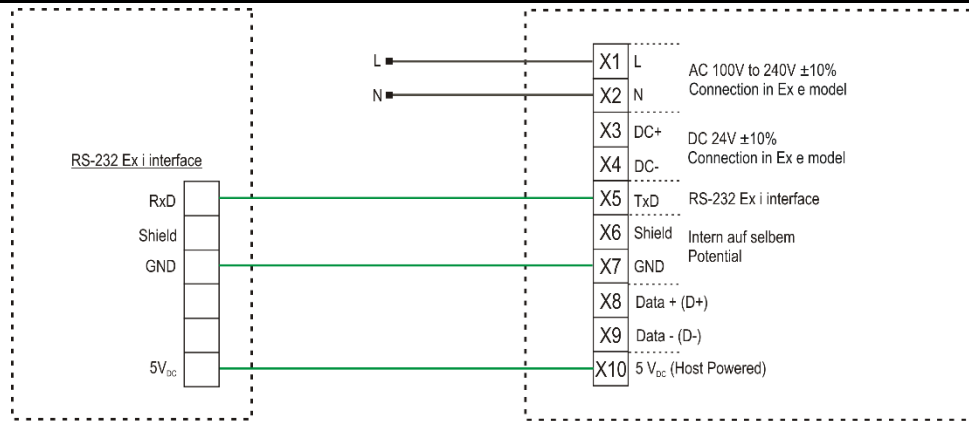

Ex-HMI/PC/Host with serial RS232-interface	Max. cable length is 15 m	Supply module Ex i BT - Bluetooth
--	---------------------------	-----------------------------------

Wiring:
 Black wire → necessary (example connection to AC)
 Green line → necessary

The signals RxD, RTS and CTS are not in use/no function internally. Only the TxD line is available to transfer data from the BCS36x8ex to the PC/host.

For data lines (green) we strongly recommend to use shielded (e.g. CAT5, similar or higher quality) cables. The Ex-HMI/PC/host must provide 5V_{DC} for the interface. The interface is "Host Powered".

Note:



The interfaces of the power supply module Ex i BT are passive.

The power supply module supplies only the hand scanner with power, but not the interface. The interface works in Ex i version with 5V_{DC}.

The interfaces themselves are supplied with power via the Ex-HMI or other Ex-device.

14.1.3 Setting/programming

The programming barcodes have been taken from the original Zebra Product Reference Guide (PRG).



The functions of the BCS3608^{ex} and BCS3678^{ex} are based on the Zebra DS3608-HP/ER and DS3678-HP/ER.

The Guide is available to download from Zebra or from BARTEC:

Zebra support download page:



<https://www.zebra.com/us/en/support-downloads.html>

- Barcode Scanners
- Ultra Rugged Scanners – DS3608-HP/DS3678-HP and DS3608-ER/DS3678-ER

BARTEC download page:

<http://automation.bartec.de/indexE.htm>

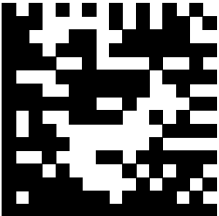
- Data capture

Function	Barcode
<p>Set factory defaults Scan the barcode for factory settings to remove all customized defaults and set the digital scanner to factory default settings (factory defaults can be found in the Zebra PRG, Appendix A, Standard Default Parameters).</p>	
<p>Default settings</p>	<p>Hand-held scanner is set as HID device.</p>
<p>Unpairing Delete all existing Bluetooth connections.</p>	
<p>Prepare the scanner to pair with the supply module Ex i BT. Scan in the “Bluetooth Serial Port Profile (Master)” barcode.</p>	

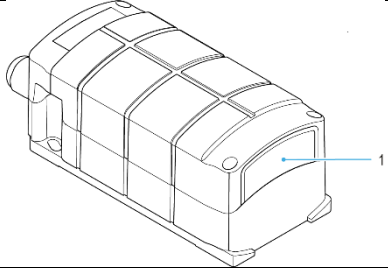

The **“Bluetooth Serial Port Profile (Master)”** barcode can be created at any time using the Zebra 123Scan utility.

<p>Scan in the pairing barcode on the supply module Ex i BT. The barcode can be found on the cover.</p>	
---	---

- i** The barcode for pairing can be created at any time using the Zebra 123Scan utility. Use the MAC address of the Bluetooth module in the supply module Ex i BT for this.
- i** Programming/setting via the Zebra 123 Scan Utility is not supported via the supply module. A programming cable is required.
- i** The hand-held scanner is paired to the supply module Ex i BT via Bluetooth. The supply module Ex i BT transmits serial data on the output side. You can find the set factory defaults below.



<p>Default settings of the Bluetooth module in the supply module Ex i BT</p>	<p><u>RS-232 host parameters</u></p> <p>Baud rate: 9600 baud</p> <p>Parity: None</p> <p>Stop bits: 1-bit</p> <p>Data bits: 8-bit</p> <p>Hardware handshaking: None</p> <p>Software handshaking: None</p>
---	--

- i** Further customized settings can be performed with the help of the Zebra Product Reference Guide or the Zebra 123Scan utility.

14.1.4 **Note on base station when used only for charging**

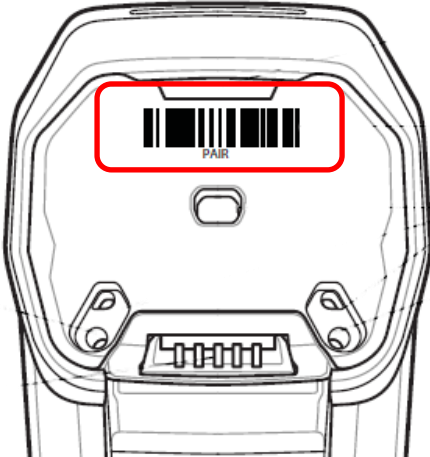

Observe the following notes when the base station is only used for charging to avoid possible problems with the Bluetooth connection.

“Pair on Contacts“ deactivate	
<p>If the base station is only used as a charging station, we recommend deactivating the "Pair on Contacts" function. Otherwise, the scanner will be automatically connected to the base station via the contacts. This means that the connection with another Bluetooth device such as the universal supply module must be done again.</p>	
<p>“Enable Pair On Contacts” The function is enabled in the factory settings and enables connection via the contacts on the base station.</p>	
<p>“Disable Pair on Contacts”</p>	
Cover the pairing barcode on the base station	
<p>If the base station is only used as a charging station, we recommend covering the pairing barcode on the base station so that a connection with the base station is not created by accidental scanning when inserting the scanner. This will result in the need to reconnect to another Bluetooth device such as the Universal Power Supply Module.</p>	
	

14.1.5 Testing communication/data transmission

The communication/data transmission on the Ex-HMI device can be tested with the help of a terminal program or a software keyboard wedge.



A software wedge or other application must be installed on the Ex-HMI device for data transmission when using a supply module Ex i BT.
 The software wedge or other application is used to convert the incoming data to a keyboard entry and to enter the data into the field currently active on the host PC.

Terminal program

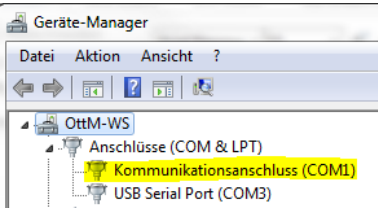
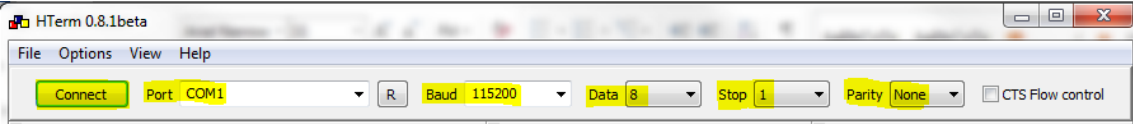
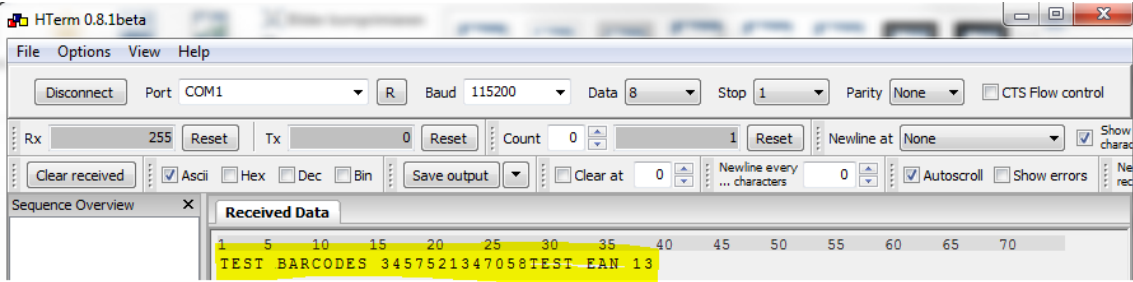

The test with a terminal program described below was conducted with the H-Term application. Alternatively any other terminal program that supports serial communication may be used.

Testing communication/data transmission
Open terminal program
Select serial interface to which the BCS3608 ^{ex} is connected (COM1 in the example). Can be checked in the device manager.

Perform settings in the terminal program and press 'Connect'.

Read barcode with scanner and check in the terminal program that the data are displayed.

Data transmission is OK if the barcode data is displayed in the "Received Data" window. If not, check connection and programming.

15. Supply module Ex i BT with BCS3678^{ex} hand-held scanner

15.1 Connection USB via supply module Ex i BT – type: 17-A1Z0-0028 (e.g. on Ex-HMI)

15.1.1 Components required

Functional system	
BCS3678^{ex}-IS ATEX / IECEx Zone 1/21 NEC / CEC Class I, II, III Division 1	
1 x	Bluetooth BCS3678 ^{ex} hand-held scanner
	Type: 17-A1S4-2HP1
1 x	Supply module Ex i BT for hand-held scanners
	ATEX / IECEx Zone 1/21 Type: 17-A1Z0-0028
To be provided by the customer	
1 x	1 x USB connection cable to the host PC. Maximum cable length supported: 5 m Number of cores and recommended cable cross section: see BARTEC User Manual <u>NB:</u> – USB only functions as SPP (Serial Port Profile), HID is not supported. The universal supply module is detected by the host PC as a serial connection (virtual COM interface) – Please use standard, shielded data lines to prevent external disturbances. Recommendation: e.g. use CAT5, similar or higher quality cables
1 x	Ex-HMI device with USB 2.0 or USB 3.0 interface



The Ex relevant data of the power supply module Ex i BT must match the Ex-relevant data of the Ex- HMI or any other Ex device.

The Ex-relevant data of the BARTEC systems can be found in the corresponding Ex certificates, user manuals and data sheets. (www.bartec.com)

1 x	Terminal program or software keyboard wedge for testing virtual COM communication and data transmission on the host PC.
-----	---

15.1.2 Connection

Diagram

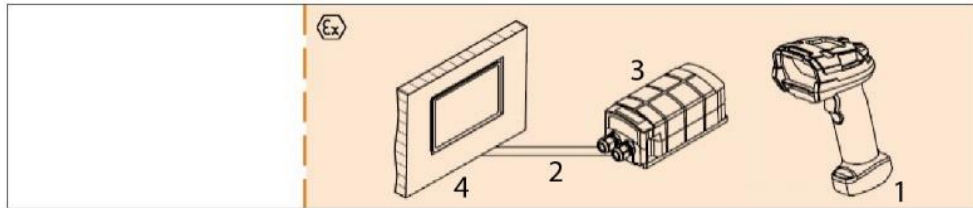

Pos.	Description
1	BCS 3678 ^{ex} hand-held scanner
2	USB data cable from Ex-HMI device to the supply module Ex i BT (max. 5m)
	Power supply (100 to 240 V _{AC} ±10% / 50/60 Hz or 24 V _{DC} ±10% 0.4A) Note: NEC/CEC version only with 24V _{DC} .
3	Supply module Ex i BT for hand-held scanner
4	Ex-HMI device Note: The Ex-HMI device can be replaced by any other Ex device with serial interface. It is important that the Ex-relevant data must be compatible with the BARTEC components. See BARTEC User Manual Chapter: "Ex-relevant values when connected to power supply module or other systems".

Supply module Ex i BT

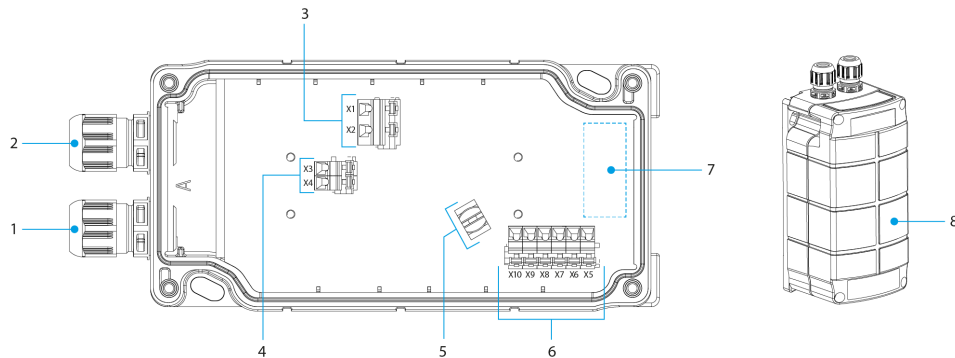

Pos.	Description	Function
1	Cable gland	Feed data cable to terminals
2	Cable gland	Feed power cord to terminals
3	Terminals X1 to X2	Connect 100 to 240 V _{AC} power supply
4	Terminals X3 to X4	Connect 24 V _{DC} power supply
5	Shield clamp for ferrite core	The ferrite core is only needed when using the USB-SPP interface.
6	Terminals X5 to X10	Connect data line
7	7-pole round plug N/A in the Bluetooth version	Plug for wired hand-held scanner
8	Cover	Protect / seal terminal connection chamber

Supply module Ex i BT - terminal assignment		
Terminal	Mains connection / USB interface	
X1	L = 100 V _{AC} to 240 V _{AC} ±10% / 50/60 Hz	
X2	N = Neutral conductor	
X3	24 V _{DC+} ±10% / 0.4A	
X4	24 V _{DC-} ±10% / 0.4A	
X5	RS232	TxD
X6		Shield
X7	USB-SPP	Ground (GND)
X8		Data + (D+)
X9		Data - (D-)
X10		5V (Host Powered / 5V of the USB interface on host side)



The interface is only selected by correctly connecting the data line to the corresponding terminals.

Supply module Ex i BT – FTDI-FT232-R driver

Driver for the supply module Ex i BT.

On connecting the supply module, the drivers are automatically detected by the Windows operating system and installed if necessary.



If not detected automatically, the driver can be downloaded from the BARTEC download page or directly from the FTDI website (<https://www.ftdichip.com/>) and installed manually.

The driver is compatible with:

- Windows 10, 8.1, 8, 7 --- 32/64 bit

BARTEC download page: <http://automation.bartec.de/indexE.htm>

Wiring of supply module Ex i BT – USB-SPP interface

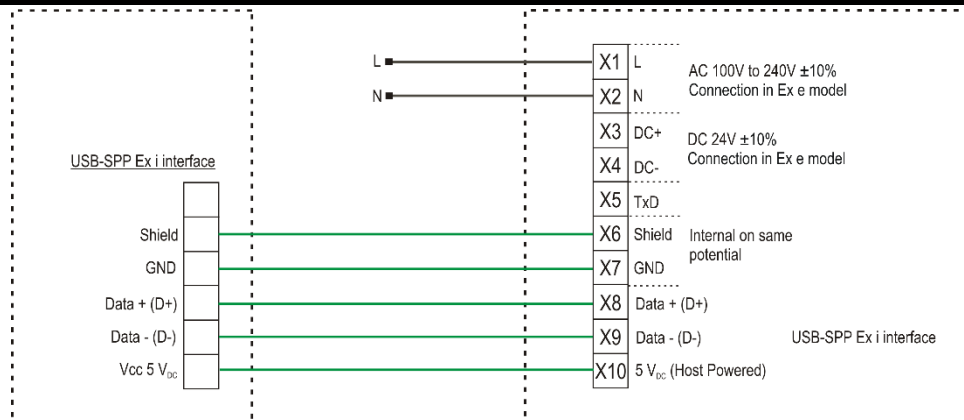

Ex-HMI/PC/Host with USB Interface USB-SPP = Serial Port Profile USB = virtual serial COM port	Max. cable length is 5 m	Supply module Ex i BT - Bluetooth
---	--------------------------	-----------------------------------

Wiring:
 Black wire → necessary (example connection to AC)
 Green line → necessary
 For data lines (green) we strongly recommend to use shielded (e.g. CAT5, similar or higher quality) cables.
 The Ex-HMI/PC/host must provide 5V_{DC} for the interface. The interface is "Host Powered".

Note:



The interfaces of the power supply module Ex i BT are passive.

The power supply module supplies only the hand scanner with power, but not the interface.

The interfaces themselves are supplied with power via the Ex-HMI or other Ex-device.

Ferrite core for data line (only when using the USB-SPP interface)

On delivery, a plastic bag with a ferrite core is included in each supply module.



The ferrite core is only required when using the USB-SPP interface.
It is used for shielding and to avoid external interference on the data line.

The ferrite core must be attached as follows.

- Strip the data line
- Slide the ferrite core over the data line
- Place data line with bare shield in the shield terminal (on the board)
- Place the data line on the terminal strip.

Ferrite core for shielding external interference signals

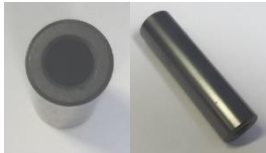

Installation in a supply module

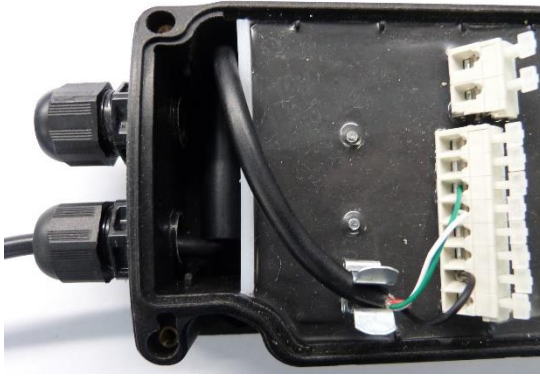

15.1.3 Setting/programming

The programming barcodes have been taken from the original Zebra Product Reference Guide (PRG).



The functions of the BCS3608^{ex} and BCS3678^{ex} are based on the Zebra DS3608-HP/ER and DS3678-HP/ER.

The Guide is available to download from Zebra or from BARTEC:

Zebra support download page:



<https://www.zebra.com/us/en/support-downloads.html>

- Barcode Scanners
- Ultra Rugged Scanners – DS3608-HP/DS3678-HP and DS3608-ER/DS3678-ER

BARTEC download page:

<http://automation.bartec.de/indexE.htm>

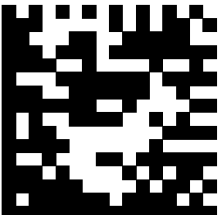
- Data capture

Function	Barcode
<p>Set factory defaults Scan the barcode for factory settings to remove all customized defaults and set the digital scanner to factory default settings (factory defaults can be found in the Zebra PRG, <i>Appendix A, Standard Default Parameters</i>).</p>	
<p>Default settings</p>	<p>Hand-held scanner is set as HID device.</p>
<p>Unpairing Delete all existing Bluetooth connections.</p>	
<p>Prepare the scanner to pair with the supply module Ex i BT. Scan in the “Bluetooth Serial Port Profile (Master)” barcode.</p>	



The “**Bluetooth Serial Port Profile (Master)**” barcode can be created at any time using the Zebra 123Scan utility.

Scan in the pairing barcode on the supply module Ex i BT.
 The barcode can be found on the cover.

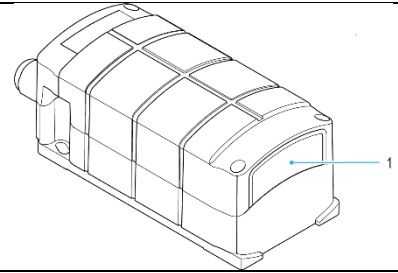

The barcode for pairing can be created at any time using the Zebra 123Scan utility. Use the MAC address of the Bluetooth module in the supply module Ex i BT for this.



Programming/setting via the Zebra 123 Scan Utility is not supported via the supply module Ex i BT.

A programming cable is required.



The hand-held scanner is paired to the supply module Ex i BT via Bluetooth. The supply module Ex i BT transmits serial data on the output side. The connected USB interface is detected by the host PC as a virtual serial (COM) interface.

Default settings of the Bluetooth module in the supply module Ex i BT

RS-232 host parameters

Baud rate:	9600 baud
Parity:	None
Stop bits:	1-bit
Data bits:	8-bit
Hardware handshaking:	None
Software handshaking:	None





Further customized settings can be performed with the help of the Zebra Product Reference Guide or the Zebra 123Scan utility.

15.1.4 Note on base station when used only for charging

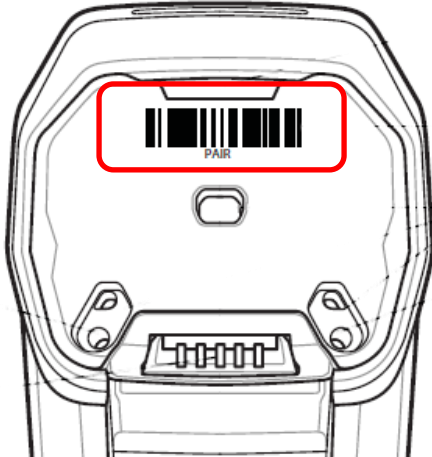

Observe the following notes when the base station is only used for charging to avoid possible problems with the Bluetooth connection.

“Pair on Contacts“ deactivate	
<p>If the base station is only used as a charging station, we recommend deactivating the "Pair on Contacts" function. Otherwise, the scanner will be automatically connected to the base station via the contacts. This means that the connection with another Bluetooth device such as the universal supply module must be done again.</p>	
<p>“Enable Pair On Contacts” The function is enabled in the factory settings and enables connection via the contacts on the base station.</p>	
<p>“Disable Pair on Contacts”</p>	
Cover the pairing barcode on the base station	
<p>If the base station is only used as a charging station, we recommend covering the pairing barcode on the base station so that a connection with the base station is not created by accidental scanning when inserting the scanner. This will result in the need to reconnect to another Bluetooth device such as the Universal Power Supply Module.</p>	
	

15.1.5 Testing communication/data transmission

The communication/data transmission on the Ex-HMI device can be tested with the help of a terminal program or a software keyboard wedge.



A software wedge or other application must be installed on the Ex-HMI device for data transmission when using a supply module Ex i BT.
The software wedge or other application is used to convert the incoming data to a keyboard entry and to enter the data into the field currently active on the Ex-HMI device.

Terminal program

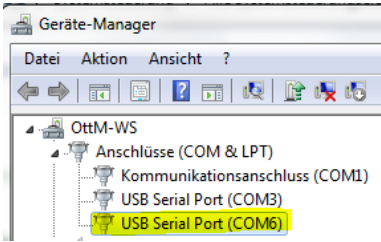
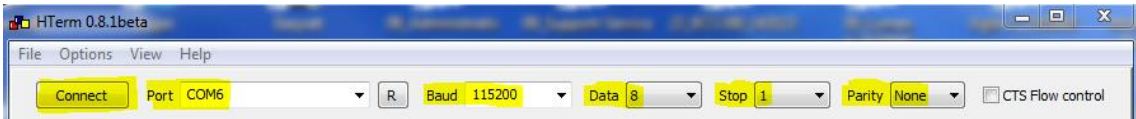
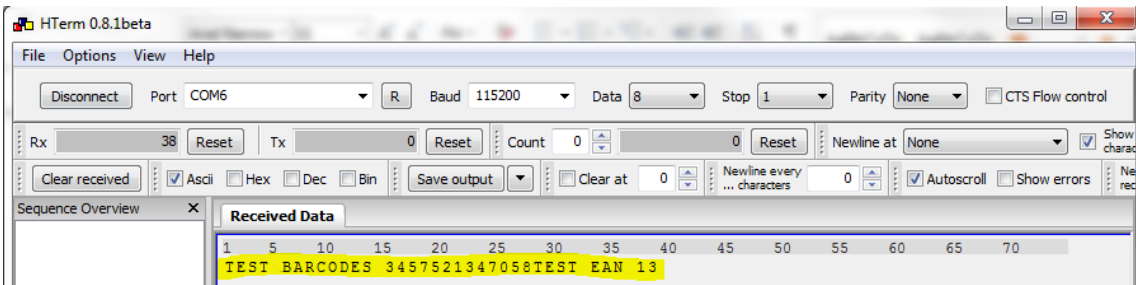

The test with a terminal program described below was conducted with the H-Term application. Alternatively any other terminal program that supports serial communication may be used.

Testing communication/data transmission
Open terminal program
Select serial interface to which the BCS3608 ^{ex} is connected (COM6 in the example). Can be checked in the device manager.

Perform settings in the terminal program and press 'Connect'.

Read barcode with scanner and check in the terminal program that the data are displayed.

Data transmission is OK if the barcode data is displayed in the "Received Data" window. If not, check connection and programming.

16. Wired BCS3608^{ex} hand-held scanner with HMI limiting cable

16.1 Connection USB limiting cable (e.g. on Ex-HMI)

16.1.1 Components required

Functional system	
BCS3608 ^{ex} -NI	
ATEX / IECEx Zone 2/22	
NEC / CEC Class I, II, III Division 2	
1 x	Wired BCS3608 ^{ex} hand-held scanner
	Type: B7-A2S4-2HP0
1 x	HMI limiting cable for connection between Ex-HMI device and hand-held scanner
	Type: B7-A2Z0-0041 or B7-A2Z0-0054
To be provided by the customer	
1 x	Ex-HMI device with USB 2.0 or USB 3.0 interface

Ex-relevant and functional parameters required for the function:

USB interface must supply 5V_{DC}/500 mA output side.

If these values are not supplied by the interface, connection can be realized via universal supply module.



The Ex-relevant data of the hand-held scanner must match the Ex-relevant data of the Ex-HMI or any other Ex-device.

The Ex-relevant data of the BARTEC systems can be found in the corresponding Ex certificates, user manuals and data sheets. (www.bartec.com)

16.1.2 Connection

Diagram

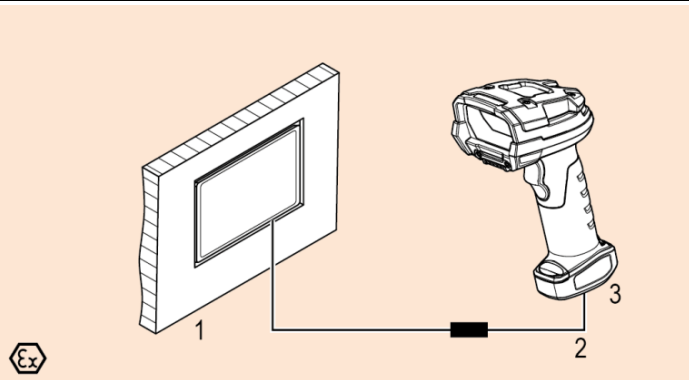

Pos.	Description
1	Ex-HMI device Note: The Ex-HMI device can be replaced by any other Ex device with serial interface. Functional requirement: USB interface must supply 5V _{DC} /500 mA on the output side. It is important that the Ex-relevant data must be compatible with the BARTEC components. See BARTEC User Manual Chapter: "Ex-relevant values when connected to power supply module or other systems".
2	HMI limiting cable (B7-A2Z0-0041 or B7-A2Z0-0054)
3	BCS 3608 ^{ex} hand-held scanner

Wiring of HMI limiting cable – USB

RJ-50	Cable diagram	Description
		Black = GND
PIN 1		White = D+
PIN 10		Green = D-
		Red = V+
B7-A2Z0-0041	HMI limiting cable, USB; 1.9m; plain	
B7-A2Z0-0054	HMI limiting cable, USB; 4.5m; plain	

16.1.3 Setting/programming

The programming barcodes have been taken from the original Zebra Product Reference Guide (PRG).



The functions of the BCS3608^{ex} and BCS3678^{ex} are based on the Zebra DS3608-HP/ER and DS3678-HP/ER.

The Guide is available to download from Zebra or from BARTEC:

Zebra support download page:

<https://www.zebra.com/us/en/support-downloads.html>

- Barcode Scanners
- Ultra Rugged Scanners – DS3608-HP/DS3678-HP and DS3608-ER/DS3678-ER

BARTEC download page:

<http://automation.bartec.de/indexE.htm>

- Data capture

Function	Barcode
<p>Set factory defaults Scan the barcode for factory settings to remove all customized defaults and set the digital scanner to factory default settings (factory defaults can be found in the Zebra PRG, Appendix A, Standard Default Parameters).</p>	
<p>Default settings</p>	<p>Hand-held scanner is set as HID device.</p>



Further customized settings can be performed with the help of the Zebra Product Reference Guide or the Zebra 123Scan utility.

16.1.4 Testing communication/data transmission

The hand-held scanner BCS3608^{ex} is detected as HID device. The scanned data is transmitted as HID (Human Interface Device). The hand-held scanner functions in this mode as a keyboard entry.

Testing communication/data transmission

Open any program, such as Word, Notepad, Excel or other.

Read the barcode with the scanner and check that data are displayed in the active field in the open program.

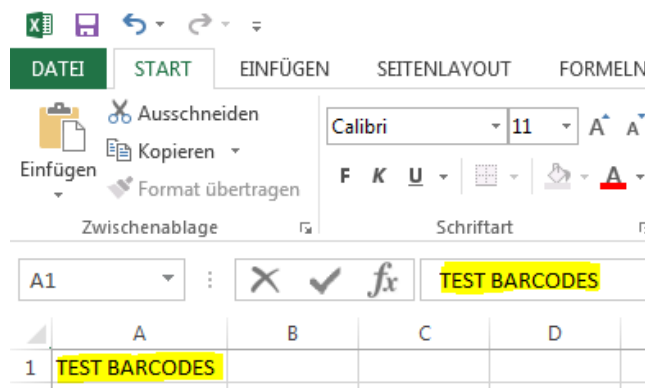

Data transmission is OK when the barcode data is displayed.

If not, check connection and programming.